

VALVULAS CON ACTUADOR

ACTUADORES NEUMATICOS Y ELECTRICOS

ACTUADOR NEUMATICO S/E-N/C

Referencia: **U404**



Características

Referencia	Material	Temperatura	Presión mando (bar)
U030	Aluminio anodizado	-20 .. +80° C	3..8 bar
U050	Aluminio anodizado	-20 .. +80° C	3..8 bar
U050-F04	Aluminio anodizado	-20 .. +80° C	3..8 bar
U070	Aluminio anodizado	-20 .. +80° C	3..8 bar
U150	Aluminio anodizado	-20 .. +80° C	3..8 bar
U170	Aluminio anodizado	-20 .. +80° C	3..8 bar
U200	Aluminio anodizado	-20 .. +80° C	3..8 bar
U250	Aluminio anodizado	-20 .. +80° C	3..8 bar
U300	Aluminio anodizado	-20 .. +80° C	3..8 bar
U350	Aluminio anodizado	-20 .. +80° C	3..8 bar
U400	Aluminio anodizado	-20 .. +80° C	3..8 bar
U450	Aluminio anodizado	-20 .. +80° C	3..8 bar
U500	Aluminio anodizado	-20 .. +80° C	3..8 bar
U550	Aluminio anodizado	-20 .. +80° C	3..8 bar
U600	Aluminio anodizado	-20 .. +80° C	3..8 bar
U650	Aluminio anodizado	-20 .. +80° C	3..8 bar
U052	Aluminio anodizado	-20 .. +80° C	3..8 bar
U053	Aluminio anodizado	-20 .. +80° C	3..8 bar
U074	Aluminio anodizado	-20 .. +80° C	3..8 bar
U154	Aluminio anodizado	-20 .. +80° C	3..8 bar
U174	Aluminio anodizado	-20 .. +80° C	3..8 bar
U204	Aluminio anodizado	-20 .. +80° C	3..8 bar
U254	Aluminio anodizado	-20 .. +80° C	3..8 bar
U304	Aluminio anodizado	-20 .. +80° C	3..8 bar
U354	Aluminio anodizado	-20 .. +80° C	3..8 bar
U404	Aluminio anodizado	-20 .. +80° C	3..8 bar
U454	Aluminio anodizado	-20 .. +80° C	3..8 bar
U504	Aluminio anodizado	-20 .. +80° C	3..8 bar
U554	Aluminio anodizado	-20 .. +80° C	3..8 bar
U604	Aluminio anodizado	-20 .. +80° C	3..8 bar

Tipo U030 - U030 Type

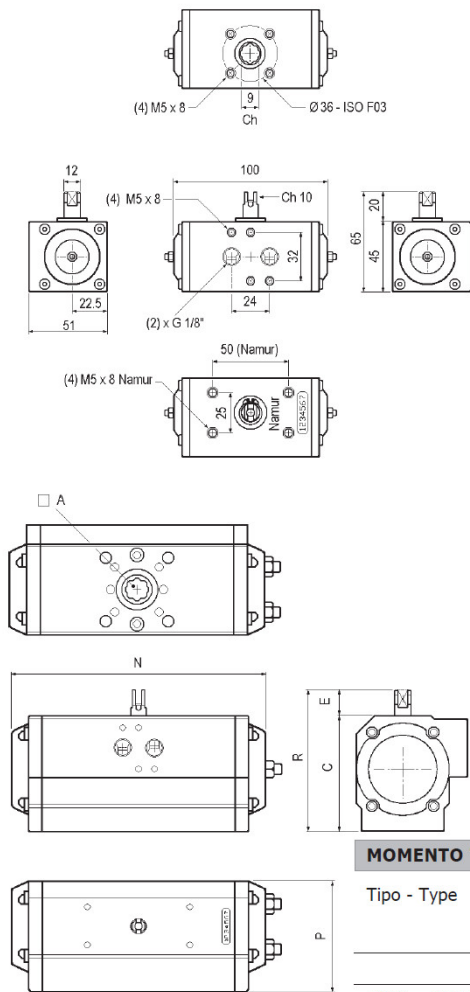

DIMENSIONI - DIMENSIONS

mm.

CODICE DE-DA	CODE SE-SR	molle springs	A ISO 5211	R	P	N	C	E
U050	U052	(2x) 2	11 - F03 M5 11 - F04 M5	101	67	119	71	30
U070	U074	(2x) 4	11 - F03 M5 11 - F05 M6	98	70	160	68	30
U150	U154	(2x) 4	14 - F05 M6 14 - F07 M8	111	81	175	81	30
U170	U174	(2x) 4	14 - F05 M6 14 - F07 M8	111	81	207	81	30
U200	U204	(2x) 4	17 - F05 M6 17 - F07 M8	128	96	186	98	30
U250	U254	(2x) 4	17 - F05 M6 17 - F07 M8	128	96	248	98	30
U300	U304	(2x) 4	17 - F05 M6 17 - F07 M8	147	114	241	117	30
U350	U354	(2x) 4	22 - F07 M8 22 - F10 M10	196	138	246	166	30
U400	U404	(2x) 4	22 - F07 M8 22 - F10 M10	196	138	290	166	30
U450	U454	(2x) 4	22 - F07 M8 22 - F10 M10	208	151	351	178	30
U500	U504	(2x) 4	27 - F10 M10 27 - F12 M12	248	185	361	218	30
U550	U554	(2x) 4	27 - F10 M10 27 - F12 M12	248	185	418	218	30
U600	U604	(2x) 4	36 - F10 M10 36 - F12 M12	305	235	502	275	30

MOMENTO TORCENTE ATTUATORI - OUTPUT TORQUES OF ACTUATORS (Nm)

Tipo - Type	Molle - Springs		Pressione Alimentazione Air Supply (bar)				Consumo Aria Air Consumption Ciclo Tot / Full Cycle	Peso Weight
	Start	End	End	End	End	End		
	8 (2 x 4)		4.0	5.0	5.6	6.0	NLt	Kg.
U030 DE-DA	-	-	5.34	6.67	7.5	8.04	0.07	0.47
U050 DE-DA	-	-	10.1	12.6	14.1	15.1	0.22	0.91
U052 SE-SR	7.4	5.0	2.7	5.2	6.7	7.7	0.13	0.99
U070 DE-DA	-	-	16.6	20.8	23.4	25.0	0.25	1.25
U074 SE-SR	14.8	9.2	1.8	6.0	8.6	10.2	0.10	1.36
U150 DE-DA	-	-	22.0	27.5	30.9	33.0	0.41	1.50
U154 SE-SR	16.9	12.1	5.1	10.6	14.0	16.1	0.18	1.69
U170 DE-DA	-	-	29.0	36.2	40.6	43.5	0.55	2.18
U174 SE-SR	20.9	14.4	8.1	15.3	19.7	22.6	0.25	2.42
U200 DE-DA	-	-	40.0	50.0	56.5	60.0	0.71	2.15
U204 SE-SR	27.7	20.8	12.3	22.3	28.8	32.3	0.29	2.53
U250 DE-DA	-	-	60.4	75.5	84.5	90.6	1.10	3.25
U254 SE-SR	44.2	27.9	16.2	31.3	40.3	46.4	0.48	3.77
U300 DE-DA	-	-	80.4	100.5	112.7	120.6	1.40	4.15
U304 SE-SR	56.6	42.2	23.8	43.9	56.1	64	0.65	4.88
U350 DE-DA	-	-	128.8	161.1	180.4	193.3	2.45	6.45
U354 SE-SR	93.0	69.3	35.8	68.1	87.4	100.3	1.2	7.89
U400 DE-DA	-	-	161.2	201.5	225.7	241.8	3.05	7.70
U404 SE-SR	114.1	83.7	47.1	87.4	111.6	127.7	1.60	9.38
U450 DE-DA	-	-	251.6	314.5	352.7	377.4	4.40	10.65
U454 SE-SR	200.8	126.2	50.8	113.7	151.9	176.6	1.85	13.21
U500 DE-DA	-	-	362.4	453.0	509.2	543.6	4.60	16.20
U504 SE-SR	248.6	196.2	113.8	204.4	260.6	295.0	2.50	21.00
U550 DE-DA	-	-	483.1	603.9	676.4	724.7	9.00	18.50
U554 SE-SR	335.7	238.3	147.4	268.2	340.7	389.0	4.10	23.32
U600 DE-DA	-	-	732.8	916.0	1029	1099	12.50	32.70
U604 SE-SR	484.5	386.2	248.3	431.5	545.1	614.7	6.50	42.30