

# CILINDRI ISO 15552 PROFILATI Ø32-125 ISO 15552 PROFILED CYLINDERS Ø32-125



Cilindri costruiti a norma ISO 15552 in versione con tubo profilato. Caratterizzato dal design pulito e da grande resistenza e precisione di montaggio. Disponibili in versione magnetica o non, con o senza ammortizzo regolabile, a stelo singolo o passante. Ampia gamma di accessori. Su richiesta sono fornibili in varie esecuzioni speciali ed in versione conforme alla direttiva 2014/34/UE ATEX.

ISO 15552 cylinders, profiled tube version. Featuring a clean design, high resistance and mounting precision. Available with or without magnet, with or without adjustable cushioning, single or through piston rod. Wide range of mounting accessories. Special versions are available. On request compliant with 2014/34/UE ATEX directive.

## VERSIONE VERSION

CDE		CDEP	
CDEM		CDEMP	
CDEA		CDEAP	
CDEMA		CDEMAP	

## INFORMAZIONI TECNICHE TECHNICAL INFORMATION

Testate Covers	Alluminio pressofuso verniciato Painted die-casted aluminium
Tubo Tube	Alluminio anodizzato Anodized aluminium
Guarnizioni Seals	Poliuretano - NBR Polyurethane - NBR
Boccola guida Guiding bush	Bronzo sinterizzato Sintered bronze
Stelo Piston rod	Acciaio cromato Chromium coated steel
Pressione MAX MAX pressure	10 bar
Temperatura di impiego Working temperature	-20°C +80°C con aria secca -20°C +80°C with dry air
Fluido Working fluid	Aria compressa filtrata e lubrificata e non Filtered and lubricated or not compressed air

## CHIAVI DI CODIFICA CYLINDERS KEY CODE

Versione Version		Diametro Diameter	Corsa Stroke	Tipo costruttivo Design Type	Stelo Piston rod	Guarnizioni Seals
CDE	Doppio effetto non magnetico Double acting non magnetic	32	0...2700	X ISO 15552 standard ISO 15552 standard	- Acciaio cromato Chrome plated steel	- Standard
CDEM	Doppio effetto magnetico Double acting magnetic	40			I Acciaio inox AISI 304 AISI 304 Stainless steel	V Guarnizioni FKM FKM seals
CDEA	Doppio effetto con ammortizzo regolabile non magnetico Double acting with adjustable cushioning non magnetic	50				VG Guarnizione stelo FKM FKM rod seal
CDEMA	Doppio effetto con ammortizzo regolabile magnetico Double acting with adjustable cushioning magnetic	63				
CDEP	Doppio effetto stelo passante non magnetico Double acting through rod non magnetic	80				
CDEMP	Doppio effetto stelo passante magnetico Double acting through rod magnetic	100				
CDEAP	Doppio effetto stelo passante con ammortizzo regolabile non magnetico Double acting through rod with adjustable cushioning non magnetic	125				
CDEMAP	Doppio effetto stelo passante con ammortizzo regolabile magnetico Double acting through rod with adjustable cushioning magnetic					











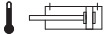

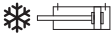
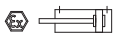
## CORSE STANDARD STANDARD STROKES

Ø (mm)	Corse standard (mm) Standard strokes (mm)													
32	10	25	40	50	80	100	125	160	200	250	300	320	400	500
40	10	25	40	50	80	100	125	160	200	250	300	320	400	500
50	10	25	40	50	80	100	125	160	200	250	300	320	400	500
63	10	25	40	50	80	100	125	160	200	250	300	320	400	500
80	10	25	40	50	80	100	125	160	200	250	300	320	400	500
100	10	25	40	50	80	100	125	160	200	250	300	320	400	500
125	10	25	40	50	80	100	125	160	200	250	300	320	400	500

## FORZE TEORICHE A 6 BAR THEORETICAL FORCES AT 6 BAR

Ø (mm)	Forza di spinta (N) Thrust force (N)	Forza di trazione (N) Traction force (N)
32	482	414
40	754	633
50	1178	989
63	1869	1681
80	3014	2720
100	4710	4416
125	7359	6877

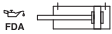
## VARIANTI VARIANTS

Simbolo Symbol	Caratteristiche Features	Simbolo Symbol	Caratteristiche Features
	Resistente alle alte temperature -10...+150°C Heat-resistant -10...+150°C		Filettature e steli su richiesta Custom made thread or piston rod
	Resistente alle basse temperature -40...+80°C Low temperature resistant -40...+80°C		Certificazione ATEX ATEX certification
	Stelo prolungato Piston rod extension		Guarnizione stelo ad elevata resistenza chimica Rod seal with increased chemical resistance
	Basso attrito Low friction		Configurazione tandem a più posizioni Multi position configuration
	Raschia stelo duro in poliestere Hard wiper in polyester		Configurazione tandem a doppia spinta Double thrust tandem configuration
	Stelo in acciaio inox Stainless steel piston rod		Configurazione tandem contrapposti anteriore Front opposed tandem configuration
	Lubrificazione FDA FDA lubrication		Configurazione tandem contrapposti posteriore Rear opposed tandem configuration

# CILINDRI ISO 15552 PROFILATI Ø32-125 ISO 15552 PROFILED CYLINDERS Ø32-125

## DOPIO EFFETTO DOUBLE ACTING

CDEØ/...X

CDEMØ/...X

CDEAØ/...X

CDEMAØ/...X

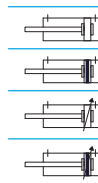
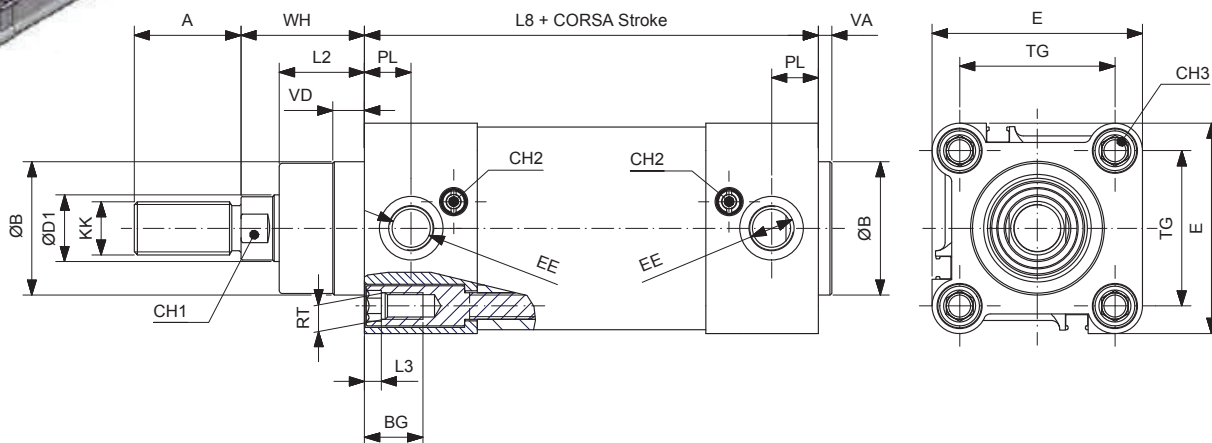

Ø	ØD1	KK	A	ØB	VD	VA	L2	RT	BG	L3	TG	EE	PL	WH	L8	E	CH1	CH2	CH3
32	12	M10x1.25	22	30	9.5	4	18	M6	16.5	5	32.5	1/8"G	12.5	26	94	47	10	3	6
40	16	M12x1.25	24	35	9.5	4	22	M6	16.5	5	38	1/4"G	14	30	105	54	13	3	6
50	20	M16x1.5	32	40	9.5	4	25.5	M8	17.5	5	46.5	1/4"G	14	37	106	63	17	3	8
63	20	M16x1.5	32	45	9.5	4	25	M8	17.5	5	56.5	3/8"G	16.5	37	121	74	17	3	8
80	25	M20x1.5	40	45	10	4	35	M10	17.5	//	72	3/8"G	17	46	128	93.5	22	4	6
100	25	M20x1.5	40	55	10	4	38	M10	17.5	//	89	1/2"G	18	51	138	110	22	4	6
125	32	M27x2	54	60	11	6	46	M12	20.5	//	110	1/2"G	18	65	160	137.5	27	4	8

## DOPIO EFFETTO PASSANTE DOUBLE ACTING THROUGH PISTON ROD

CDEPØ/...X

CDEMPØ/...X

CDEAPØ/...X

CDEMAPØ/...X

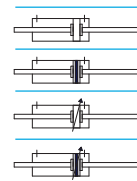
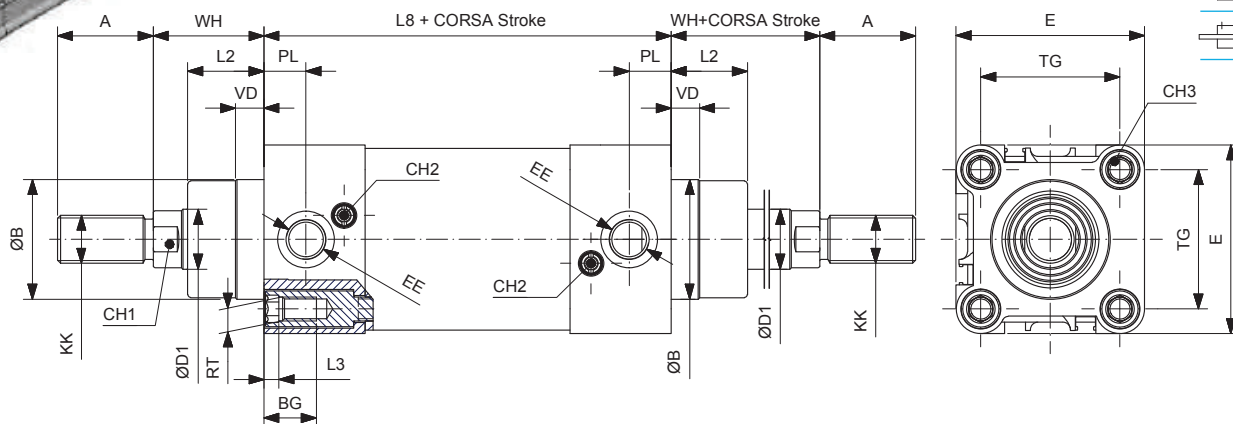
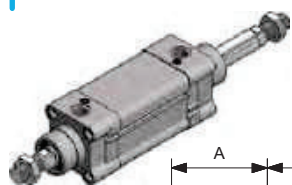

Ø	ØD1	KK	A	ØB	VD	L2	RT	BG	L3	TG	EE	PL	WH	L8	E	CH1	CH2	CH3
32	12	M10x1.25	22	30	9.5	18	M6	16.5	5	32.5	1/8"G	12.5	26	94	47	10	3	6
40	16	M12x1.25	24	35	9.5	22	M6	16.5	5	38	1/4"G	14	30	105	54	13	3	6
50	20	M16x1.5	32	40	9.5	25.5	M8	17.5	5	46.5	1/4"G	14	37	106	63	17	3	8
63	20	M16x1.5	32	45	9.5	25	M8	17.5	5	56.5	3/8"G	16.5	37	121	74	17	3	8
80	25	M20x1.5	40	45	10	35	M10	17.5	-	72	3/8"G	17	46	128	93.5	22	4	6
100	25	M20x1.5	40	55	10	38	M10	17.5	-	89	1/2"G	18	51	138	110	22	4	6
125	32	M27x2	54	60	11	46	M12	20.5	-	110	1/2"G	18	65	160	137.5	27	4	8

## ACCESSORI DI FISSAGGIO MOUNTING ACCESSORIES

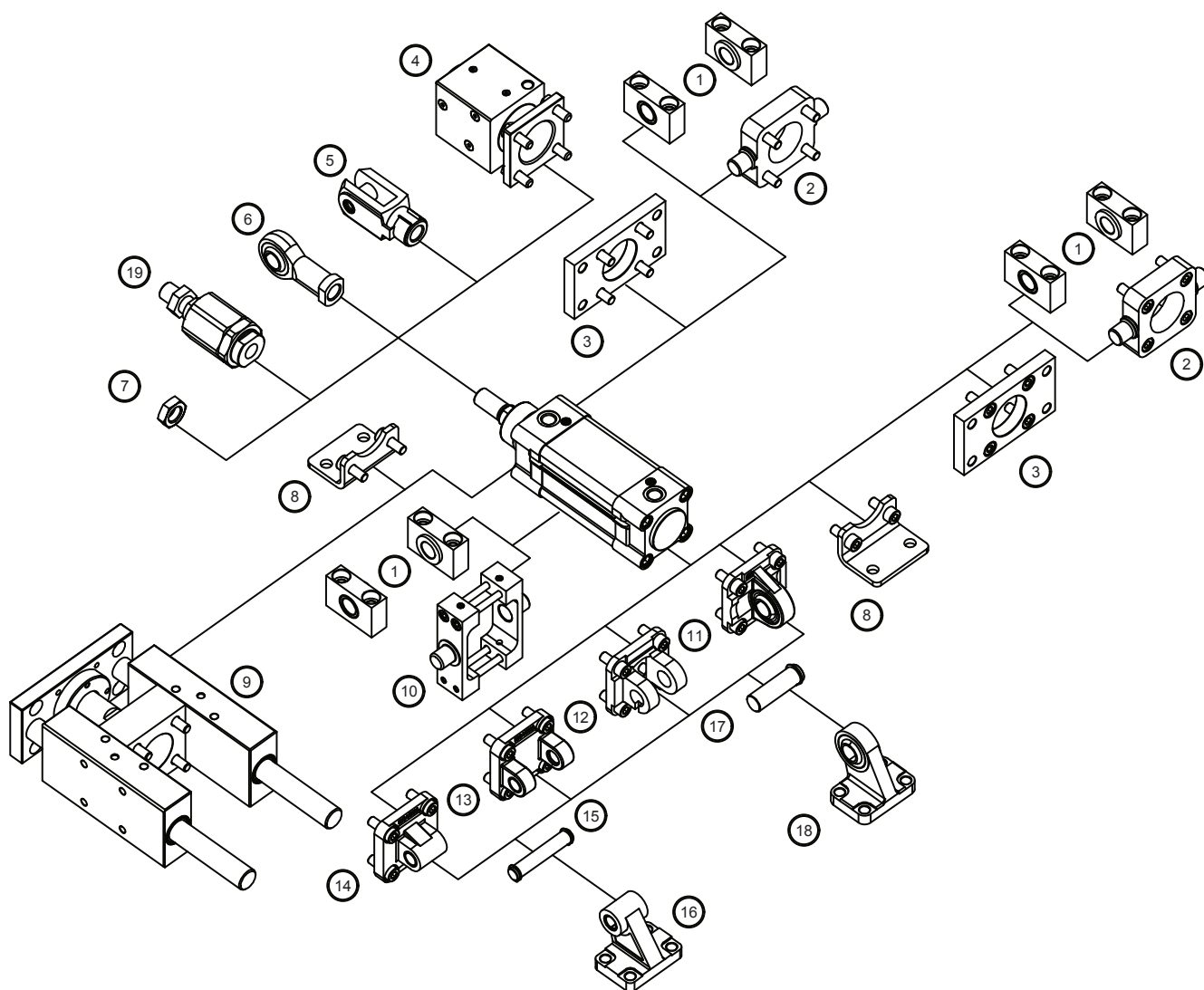

Descrizione Description	Alluminio Aluminium	Acciaio Steel	Acciaio inox Stainless steel
1 Supporto per cerniera intermedia / Support for intermediate hinge (AT4)	-	141	-
2 Cerniera oscillante anteriore-posteriore / Front-rear trunnion (MT5 / MT6)	-	141	-
3 Flangia / Flange (MF1-MF2)	-	139	152
4 Bloccastelo / Rod lock	126	-	-
5 Forcella / Clevis	-	131	147
6 Testa a snodo / Rod end	-	132	148
7 Dado per aste / Piston rod nut	-	130	146
8 Piedino basso / Low-rise pedestal (MS1)	-	138	152
9 Unità di guida / Guide unit	122	-	-
10 Cerniera intermedia per cilindri profilati / Intermediate hinge for profile cylinder (MT4)	-	139	-
11 Cerniera maschio snodata / Male hinge with spherical bearing (MP6)	137	143	-
12 Cerniera femmina stretta per snodo sferico AB6 / Clevis braket, spherical eye, straight AB6	136	142	-
13 Cerniera femmina / Female hinge (MP2)	134	142	150
14 Cerniera maschio / Male hinge (MP4)	135	-	151
15 Perno per cerniera femmina / Pivot for female hinge (AA4)	-	135	150
16 Articolazione a squadra / Square joint (AB7)	137	-	151
17 Perno per cerniera snodata AA6 / Pivot pin, spherical bearing AA6	-	136	-
18 Articolazione a squadra con testina snodata DIN 648 K / Square joint with spherical head DIN 648 K	-	138	-
19 Giunto autoallineante / Self-aligning joint	-	131	-

# CILINDRI ISO 15552 TIRANTATI Ø32-125 ISO 15552 TIE RODS CYLINDERS Ø32-125



Cilindri costruiti a norma ISO 15552 in versione con tiranti. Adatto ad applicazioni particolarmente gravose. Disponibili in versione magnetica o non, con o senza ammortizzo regolabile, a stelo singolo o passante. Ampia gamma di accessori. Su richiesta sono fornibili in varie esecuzioni speciali ed in versione conforme alla direttiva 2014/34/UE ATEX.

ISO 15552 cylinders, tie rods version. Suitable for heavy-duty applications. Available with or without magnet, with or without adjustable cushioning, single or through piston rod. Wide range of mounting accessories. Special versions are available. On request compliant with 2014/34/UE ATEX directive.

## VERSIONE VERSION

CDE		CDEP	
CDEM		CDEMP	
CDEA		CDEAP	
CDEMA		CDEMAP	

## INFORMAZIONI TECNICHE TECHNICAL INFORMATION

Testate Covers	Alluminio pressofuso verniciato Painted die-casted aluminium
Tubo Tube	Alluminio anodizzato Anodized aluminium
Guarnizioni Seals	Poliuretano - NBR Polyurethane - NBR
Boccola guida Guiding bush	Bronzo sinterizzato Sintered bronze
Stelo Piston rod	Acciaio cromato Chromium coated steel
Tiranti Tie rods	Ø32-Ø100 acciaio inox AISI303 Ø125 acciaio cromato Ø32-Ø100 AISI303 stainless steel Ø125 chromium coated steel
Pressione MAX MAX pressure	10 bar
Temperatura di impiego Working temperature	-20°C +80°C con aria secca -20°C +80°C with dry air
Fluido Working fluid	Aria compressa filtrata e lubrificata e non Filtered and lubricated or not compressed air

## CHIAVI DI CODIFICA CYLINDERS KEY CODE

CDEM	32	100	XR	-	V
------	----	-----	----	---	---

Versione Version	Diametro Diameter	Corsa Stroke	Tipo costruttivo Design Type	Stelo Piston rod	Guarnizioni Seals
CDE Doppio effetto non magnetico Double acting non magnetic	32	0...2700	XR ISO 15552 a tiranti Tie rods ISO 15552	- Acciaio cromato Chrome plated steel	- Standard
CDEM Doppio effetto magnetico Double acting magnetic	40			I Acciaio inox AISI 304 AISI 304 Stainless steel	V Guarnizioni FKM FKM seals
CDEA Doppio effetto con ammortizzo regolabile non magnetico Double acting with adjustable cushioning non magnetic	50				VG Guarnizione stelo FKM FKM rod seal
CDEMA Doppio effetto con ammortizzo regolabile magnetico Double acting with adjustable cushioning magnetic	63				
CDEP Doppio effetto stelo passante non magnetico Double acting through rod non magnetic	80				
CDEMP Doppio effetto stelo passante magnetico Double acting through rod magnetic	100				
CDEAP Doppio effetto stelo passante con ammortizzo regolabile non magnetico Double acting through rod with adjustable cushioning non magnetic	125				
CDEMAP Doppio effetto stelo passante con ammortizzo regolabile magnetico Double acting through rod with adjustable cushioning magnetic					











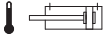

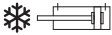

## CORSE STANDARD STANDARD STROKES

Ø (mm)	Corse standard (mm) Standard strokes (mm)													
32	10	25	40	50	80	100	125	160	200	250	300	320	400	500
40	10	25	40	50	80	100	125	160	200	250	300	320	400	500
50	10	25	40	50	80	100	125	160	200	250	300	320	400	500
63	10	25	40	50	80	100	125	160	200	250	300	320	400	500
80	10	25	40	50	80	100	125	160	200	250	300	320	400	500
100	10	25	40	50	80	100	125	160	200	250	300	320	400	500
125	10	25	40	50	80	100	125	160	200	250	300	320	400	500

## FORZE TEORICHE A 6 BAR THEORETICAL FORCES AT 6 BAR

Ø (mm)	Forza di spinta (N) Thrust force (N)	Forza di trazione (N) Traction force (N)
32	482	414
40	754	633
50	1178	989
63	1869	1681
80	3014	2720
100	4710	4416
125	7359	6877

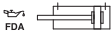
## VARIANTI VARIANTS

Simbolo Symbol	Caratteristiche Features	Simbolo Symbol	Caratteristiche Features
	Resistente alle alte temperature -10...+150°C Heat-resistant -10...+150°C		Filettature e steli su richiesta Custom made thread or piston rod
	Resistente alle basse temperature -40...+80°C Low temperature resistant -40...+80°C		Certificazione ATEX ATEX certification
	Stelo prolungato Piston rod extension		Guarnizione stelo ad elevata resistenza chimica Rod seal with increased chemical resistance
	Basso attrito Low friction		Configurazione tandem a più posizioni Multi position configuration
	Raschia stelo duro in poliestere Hard wiper in polyester		Configurazione tandem a doppia spinta Double thrust tandem configuration
	Stelo in acciaio inox Stainless steel piston rod		Configurazione tandem contrapposti anteriore Front opposed tandem configuration
	Lubrificazione FDA FDA lubrication		Configurazione tandem contrapposti posteriore Rear opposed tandem configuration

# CILINDRI ISO 15552 TIRANTATI Ø32-125 ISO 15552 TIE RODS CYLINDERS Ø32-125

## DOPIO EFFETTO DOUBLE ACTING

CDEØ/...XR

CDEMØ/...XR

CDEAØ/...XR

CDEMAØ/...XR

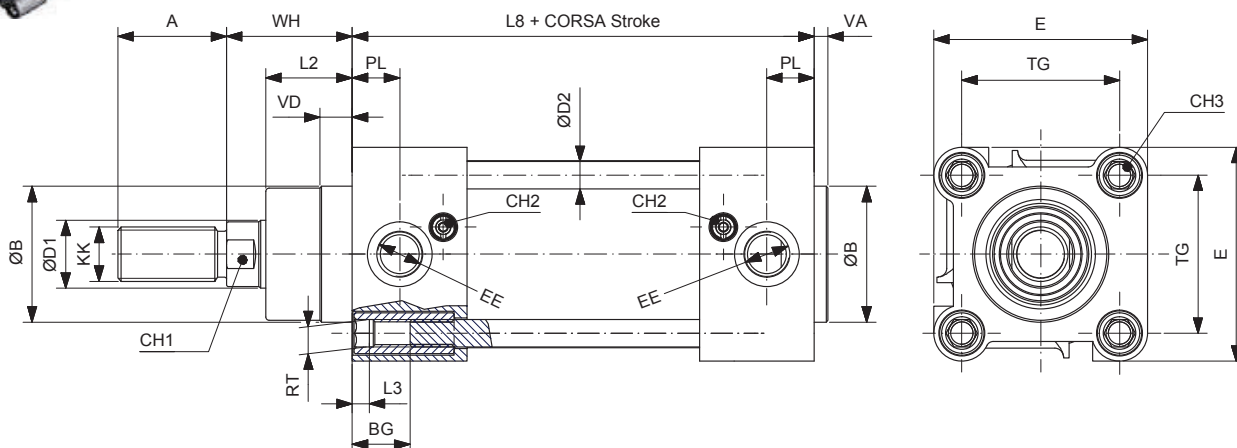
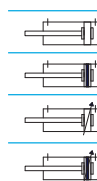

Ø	ØD1	ØD2	KK	A	ØB	VD	VA	L2	RT	BG	L3	TG	EE	PL	WH	L8	E	CH1	CH2	CH3
32	12	6	M10x1.25	22	30	9.5	4	18	M6	16.5	5	32.5	1/8"G	12.5	26	94	47	10	3	6
40	16	6	M12x1.25	24	35	9.5	4	22	M6	16.5	5	38	1/4"G	14	30	105	54	13	3	6
50	20	8	M16x1.5	32	40	9.5	4	25.5	M8	17.5	5	46.5	1/4"G	14	37	106	63	17	3	8
63	20	8	M16x1.5	32	45	9.5	4	25	M8	17.5	5	56.5	3/8"G	16.5	37	121	74	17	3	8
80	25	10	M20x1.5	40	45	10	4	35	M10	17.5	-	72	3/8"G	17	46	128	93.5	22	4	-
100	25	10	M20x1.5	40	55	10	4	38	M10	17.5	-	89	1/2"G	18	51	138	110	22	4	-
125	32	12	M27x2	54	60	11	6	46	M12	20.5	-	110	1/2"G	18	65	160	137.5	27	4	-

## DOPIO EFFETTO PASSANTE DOUBLE ACTING THROUGH PISTON ROD

CDEPØ/...XR

CDEMPØ/...XR

CDEAPØ/...XR

CDEMAPØ/...XR

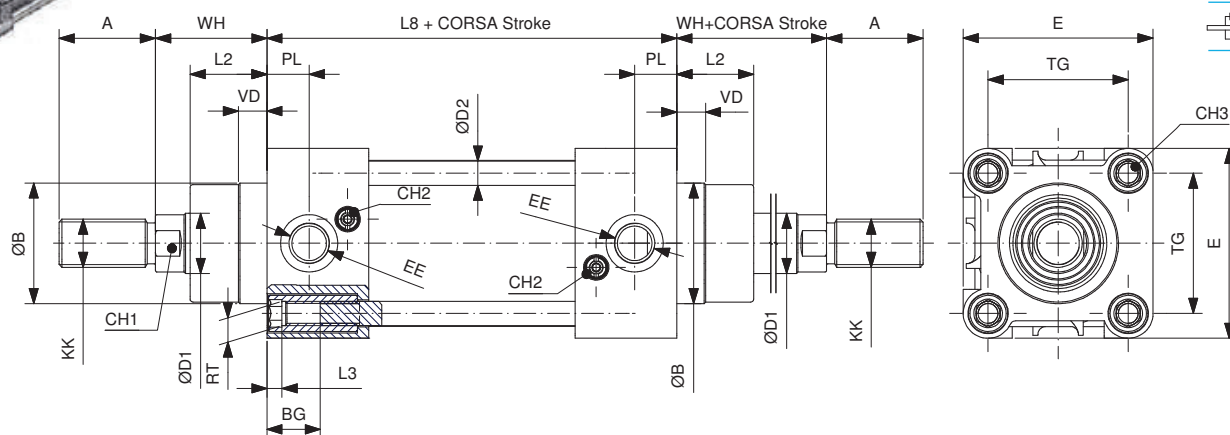
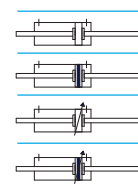
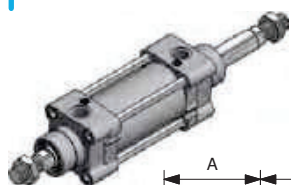

Ø	ØD1	ØD2	KK	A	ØB	VD	L2	RT	BG	L3	TG	EE	PL	WH	L8	E	CH1	CH2	CH3
32	12	6	M10x1.25	22	30	9.5	18	M6	16.5	5	32.5	1/8"G	12.5	26	94	47	10	3	6
40	16	6	M12x1.25	24	35	9.5	22	M6	16.5	5	38	1/4"G	14	30	105	54	13	3	6
50	20	8	M16x1.5	32	40	9.5	25.5	M8	17.5	5	46.5	1/4"G	14	37	106	63	17	3	8
63	20	8	M16x1.5	32	45	9.5	25	M8	17.5	5	56.5	3/8"G	16.5	37	121	74	17	3	8
80	25	10	M20x1.5	40	45	10	35	M10	17.5	-	72	3/8"G	17	46	128	93.5	22	4	-
100	25	10	M20x1.5	40	55	10	38	M10	17.5	-	89	1/2"G	18	51	138	110	22	4	-
125	32	12	M27x2	54	60	11	46	M12	20.5	-	110	1/2"G	18	65	160	137.5	27	4	-



## ACCESSORI DI FISSAGGIO MOUNTING ACCESSORIES

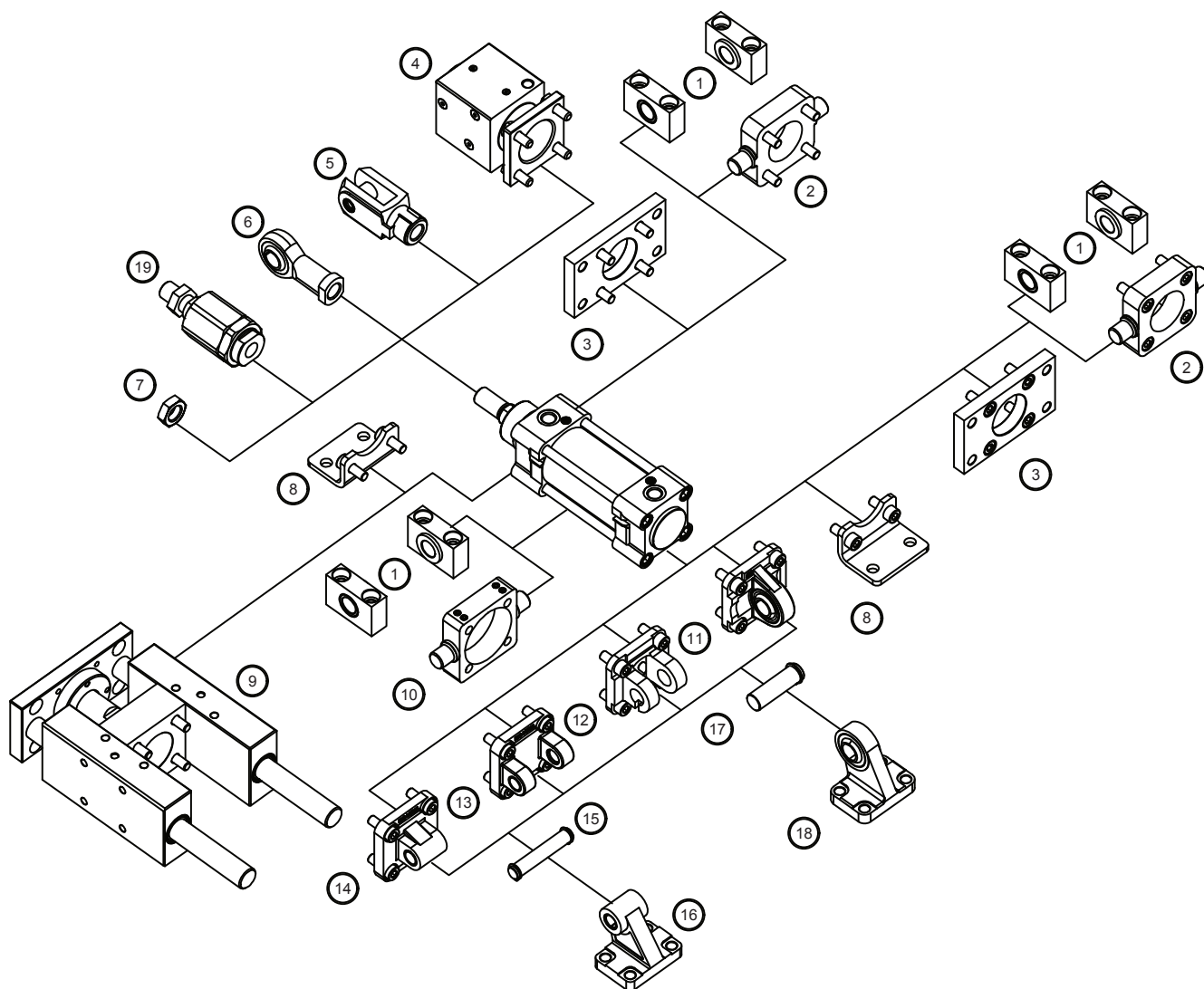

Descrizione Description	Alluminio Alluminium	Acciaio Steel	Acciaio inox Stainless steel
1 Supporto per cerniera intermedia / Support for intermediate hinge (AT4)	-	141	-
2 Cerniera oscillante anteriore-posteriore / Front-rear trunnion (MT5 / MT6)	-	141	-
3 Flangia / Flange (MF1-MF2)	-	139	152
4 Bloccastelo / Rod lock	126	-	-
5 Forcella / Clevis	-	131	147
6 Testa a snodo / Rod end	-	132	148
7 Dado per aste / Piston rod nut	-	130	146
8 Piedino basso / Low-rise pedestal (MS1)	-	138	152
9 Unità di guida / Guide unit	122	-	-
10 Cerniera intermedia / Intermediate hinge (MT4)	-	140	150
11 Cerniera maschio snodata / Male hinge with spherical bearing (MP6)	137	143	-
12 Cerniera femmina stretta per snodo sferico AB6 / Clevis braket, spherical eye, straight AB6	136	142	-
13 Cerniera femmina / Female hinge (MP2)	134	142	150
14 Cerniera maschio / Male hinge (MP4)	135	-	151
15 Perno per cerniera femmina / Pivot for female hinge (AA4)	-	135	150
16 Articolazione a squadra / Square joint (AB7)	137	-	151
17 Perno per cerniera snodata AA6 / Pivot pin, spherical bearing AA6	-	136	-
18 Articolazione a squadra con testina snodata DIN 648 K / Square joint with spherical head DIN 648 K	-	138	-
19 Giunto autoallineante / Self-aligning joint	-	131	-



# CILINDRI ISO 15552 BASSO ATTRITO Ø32-63 ISO 15552 LOW FRICTION CYLINDERS Ø32-63



Cilindri costruiti a norma ISO 15552 in versione basso attrito. Costruzione con tubo tondo in alluminio e tiranti. Disponibili in versione magnetica o non. Ampia gamma di accessori. Su richiesta sono fornibili in varie esecuzioni speciali ed in versione conforme alla direttiva 2014/34/UE ATEX.

ISO 15552 cylinders, low friction version. Aluminum tube with tie rods construction. Available with or without magnet. Wide range of mounting accessories. Special versions are available. On request complaint with 2014/34/UE ATEX directive.

## VERSIONE VERSION

CDE		CDEP	
CDEM		CDEMP	

## INFORMAZIONI TECNICHE TECHNICAL INFORMATION

Testate Covers	Alluminio pressofuso verniciato Painted die-casted aluminium
Tubo Tube	Alluminio anodizzato Anodized aluminium
Guarnizioni Seals	Poliuretano - NBR Polyurethane - NBR
Boccola guida Guiding bush	Bronzo sinterizzato Sintered bronze
Stelo Piston rod	Acciaio cromato Chromium coated steel
Tiranti Tie rods	Acciaio inox AISI303 AISI303 stainless steel
Pressione MAX MAX pressure	10 bar
Temperatura di impiego Working temperature	-20°C +80°C con aria secca -20°C +80°C with dry air
Fluido Working fluid	Aria compressa filtrata e lubrificata e non Filtered and lubricated or not compressed air

## CHIAVI DI CODIFICA CYLINDERS KEY CODE

Versione Version		Diametro Diameter	Corsa Stroke	Tipo costruttivo Design Type	Stelo Piston rod	Guarnizioni Seals
CDE	Doppio effetto non magnetico Double acting non magnetic	32	0...2700	XB Basso attrito Low friction	- Acciaio cromato Chrome plated steel   Acciaio inox AISI 304 AISI 304 Stainless steel	- Standard
CDEM	Doppio effetto magnetico Double acting magnetic	40				V Guarnizioni FKM FKM seals
CDEP	Doppio effetto stelo passante non magnetico Double acting through rod non magnetic	50				VG Guarnizione stelo FKM FKM rod seal
CDEMP	Doppio effetto stelo passante magnetico Double acting through rod magnetic	63				







## CORSE STANDARD STANDARD STROKES

Ø (mm)	Corse standard (mm) Standard strokes (mm)													
32	10	25	40	50	80	100	125	160	200	250	300	320	400	500
40	10	25	40	50	80	100	125	160	200	250	300	320	400	500
50	10	25	40	50	80	100	125	160	200	250	300	320	400	500
63	10	25	40	50	80	100	125	160	200	250	300	320	400	500

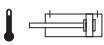
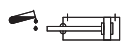
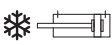
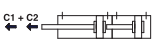
## FORZE TEORICHE A 6 BAR THEORETICAL FORCES AT 6 BAR

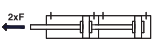
Ø (mm)	Forza di spinta (N) Thrust force (N)	Forza di trazione (N) Traction force (N)
32	482	414
40	754	633
50	1178	989
63	1869	1681

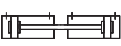
## VARIANTI VARIANTS

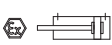
Simbolo Symbol	Caratteristiche Features	Simbolo Symbol	Caratteristiche Features
	Resistente alle alte temperature -10...+150°C Heat-resistant -10...+150°C		Guarnizione stelo ad elevata resistenza chimica Rod seal with increased chemical resistance
	Resistente alle basse temperature -40...+80°C Low temperature resistant -40...+80°C		Configurazione tandem a più posizioni Multi position configuration
	Stelo prolungato Piston rod extension		Configurazione tandem a doppia spinta Double thrust tandem configuration
	Stelo in acciaio inox Stainless steel piston rod		Configurazione tandem contrapposti anteriore Front opposed tandem configuration
	Filettature e steli su richiesta Custom made thread or piston rod		Configurazione tandem contrapposti posteriore Rear opposed tandem configuration
	Certificazione ATEX ATEX certification		

# CILINDRI ISO 15552 BASSO ATTRITO Ø32-63 ISO 15552 LOW FRICTION CYLINDERS Ø32-63

**DOPPIO EFFETTO**  
**DOUBLE ACTING**

**CDEØ/...XB**

**CDEMØ/...XB**

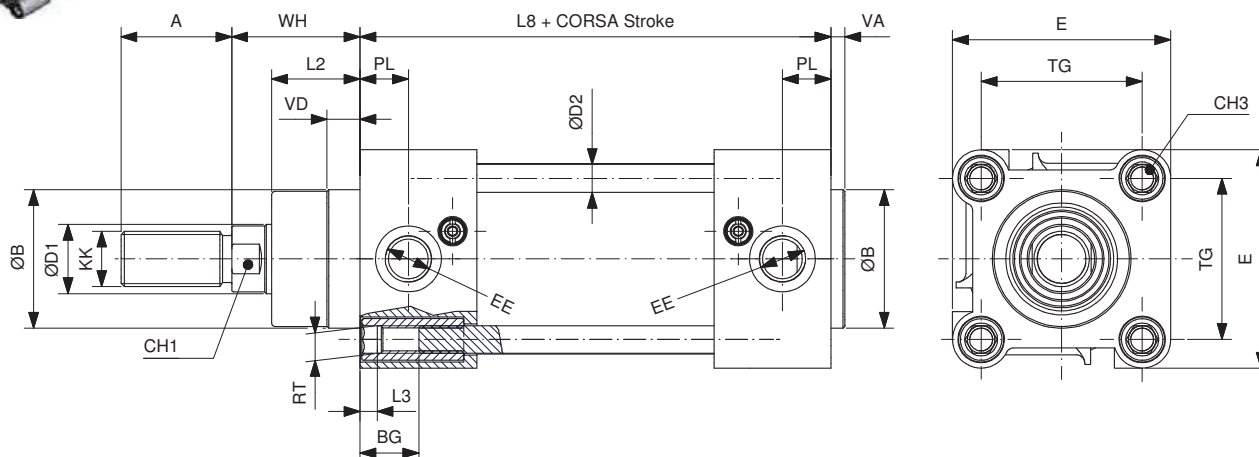

Ø	ØD1	ØD2	KK	A	ØB	VD	VA	L2	RT	BG	L3	TG	EE	PL	WH	L8	E	CH1	CH3
32	12	6	M10x1.25	22	30	9.5	4	18	M6	16.5	5	32.5	1/8"G	12.5	26	94	47	10	6
40	16	6	M12x1.25	24	35	9.5	4	22	M6	16.5	5	38	1/4"G	14	30	105	54	13	6
50	20	8	M16x1.5	32	40	9.5	4	25.5	M8	17.5	5	46.5	1/4"G	14	37	106	63	17	8
63	20	8	M16x1.5	32	45	9.5	4	25	M8	17.5	5	56.5	3/8"G	16.5	37	121	74	17	8

**DOPPIO EFFETTO PASSANTE**  
**DOUBLE ACTING THROUGH PISTON ROD**

**CDEPØ/...XB**

**CDEMPØ/...XB**

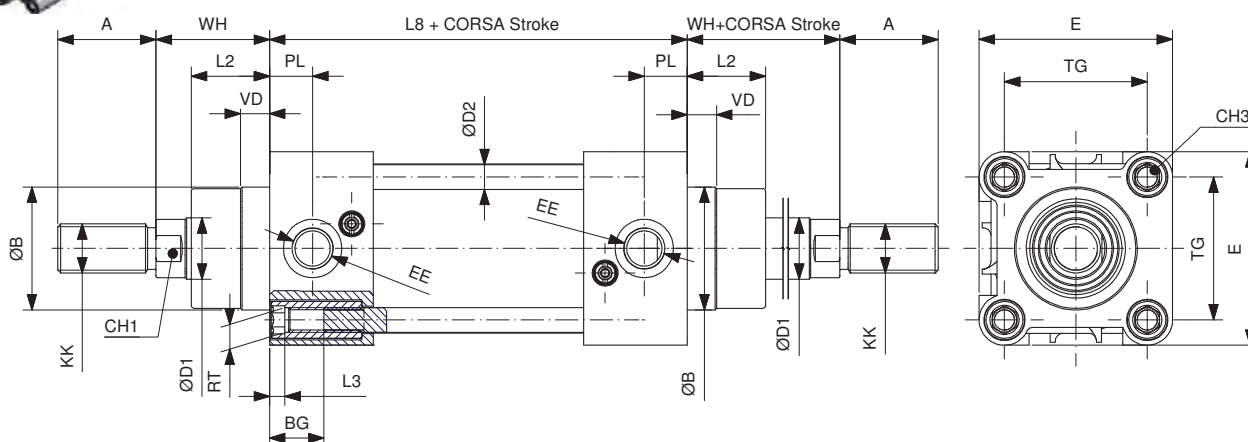
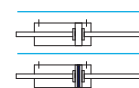

Ø	ØD1	ØD2	KK	A	ØB	VD	L2	RT	BG	L3	TG	EE	PL	WH	L8	E	CH1	CH3
32	12	6	M10x1.25	22	30	9.5	18	M6	16.5	5	32.5	1/8"G	12.5	26	94	47	10	6
40	16	6	M12x1.25	24	35	9.5	22	M6	16.5	5	38	1/4"G	14	30	105	54	13	6
50	20	8	M16x1.5	32	40	9.5	25.5	M8	17.5	5	46.5	1/4"G	14	37	106	63	17	8
63	20	8	M16x1.5	32	45	9.5	25	M8	17.5	5	56.5	3/8"G	16.5	37	121	74	17	8

## ACCESSORI DI FISSAGGIO MOUNTING ACCESSORIES

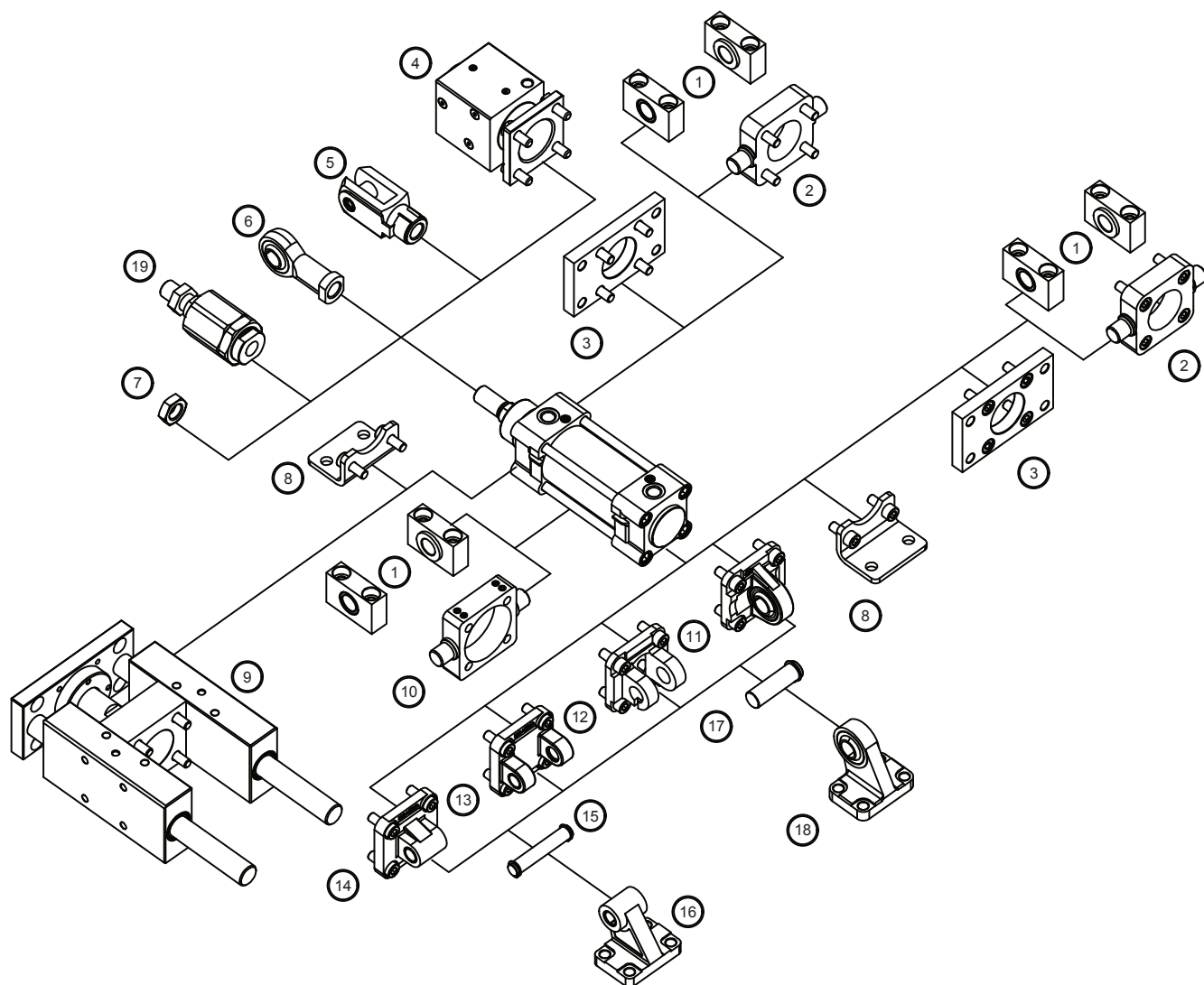

Descrizione Description	Alluminio Aluminium	Acciaio Steel	Acciaio inox Stainless steel
1 Supporto per cerniera intermedia / Support for intermediate hinge (AT4)	-	141	-
2 Cerniera oscillante anteriore-posteriore / Front-rear trunnion (MT5 / MT6)	-	141	-
3 Flangia / Flange (MF1-MF2)	-	139	152
4 Bloccastelo / Rod lock	126	-	-
5 Forcella / Clevis	-	131	147
6 Testa a snodo / Rod end	-	132	148
7 Dado per aste / Piston rod nut	-	130	146
8 Piedino basso / Low-rise pedestal (MS1)	-	138	152
9 Unità di guida / Guide unit	122	-	-
10 Cerniera intermedia / Intermediate hinge (MT4)	-	140	150
11 Cerniera maschio snodata / Male hinge with spherical bearing (MP6)	137	143	-
12 Cerniera femmina stretta per snodo sferico AB6 / Clevis braket, spherical eye, straight AB6	136	142	-
13 Cerniera femmina / Female hinge (MP2)	134	142	150
14 Cerniera maschio / Male hinge (MP4)	135	-	151
15 Perno per cerniera femmina / Pivot for female hinge (AA4)	-	135	150
16 Articolazione a squadra / Square joint (AB7)	137	-	151
17 Perno per cerniera snodata AA6 / Pivot pin, spherical bearing AA6	-	136	-
18 Articolazione a squadra con testina snodata DIN 648 K / Square joint with spherical head DIN 648 K	-	138	-
19 Giunto autoallineante / Self-aligning joint	-	131	-

# CILINDRI ISO15552 Ø160-200 ISO15552 CYLINDERS Ø160-200

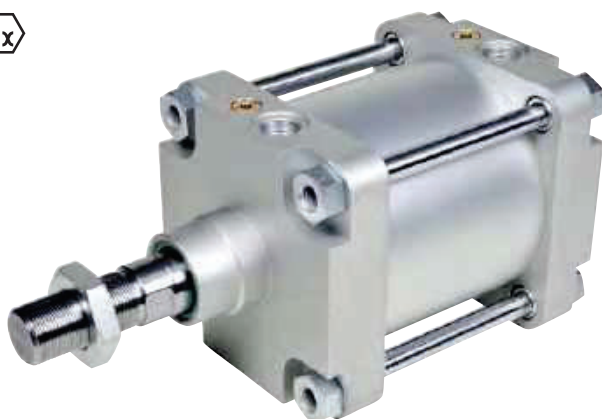

Cilindri costruiti a norma ISO 15552 in versione con tiranti. Realizzato con design pulito. Adatto ad applicazioni particolarmente gravose. Disponibili in versione magnetica o non, con o senza ammortizzo regolabile, a stelo singolo o passante. Ampia gamma di accessori. Su richiesta sono fornibili in varie esecuzioni speciali ed in versione conforme alla direttiva 2014/34/UE ATEX.

ISO 15552 cylinders, tie rods version. Featuring a clean design and suitable for heavy-duty applications. Available with or without magnet, with or without adjustable cushioning, single or through piston rod. Wide range of mounting accessories. Special versions are available. On request compliant with 2014/34/UE ATEX directive.

## VERSIONE VERSION

CDE		CDEP	
CDEM		CDEMP	
CDEA		CDEAP	
CDEMA		CDEMAP	

## INFORMAZIONI TECNICHE TECHNICAL INFORMATION

Testate Covers	Alluminio pressofuso verniciato Painted die-casted aluminium
Tubo Tube	Alluminio anodizzato Anodized aluminium
Guarnizioni Seals	Poliuretano - NBR Polyurethane - NBR
Boccola guida Guiding bush	Bronzo sinterizzato Sintered bronze
Stelo Piston rod	Acciaio cromato Chromium coated steel
Tiranti Tie rods	Acciaio cromato Chromium coated steel
Pressione MAX MAX pressure	10 bar
Temperatura di impiego Working temperature	-20°C +80°C con aria secca -20°C +80°C with dry air
Fluido Working fluid	Aria compressa filtrata e lubrificata e non Filtered and lubricated or not compressed air

## CHIAVI DI CODIFICA CYLINDERS KEY CODE

Versione Version		Diametro Diameter	Corsa Stroke	Tipo costruttivo Design Type	Stelo Piston rod	Guarnizioni Seals
CDEM		160	100	X	-	V
CDE	Doppio effetto non magnetico Double acting non magnetic	160	0...2700	X ISO 15552 standard ISO 15552 standard	- Acciaio cromato Chrome plated steel	- Standard
CDEM	Doppio effetto magnetico Double acting magnetic	200			I Acciaio inox AISI 304 AISI 304 Stainless steel	V Guarnizioni FKM FKM seals
CDEA	Doppio effetto con ammortizzo regolabile non magnetico Double acting with adjustable cushioning non magnetic					VG Guarnizione stelo FKM FKM rod seal
CDEMA	Doppio effetto con ammortizzo regolabile magnetico Double acting with adjustable cushioning magnetic					
CDEP	Doppio effetto stelo passante non magnetico Double acting through rod non magnetic					
CDEMP	Doppio effetto stelo passante magnetico Double acting through rod magnetic					
CDEAP	Doppio effetto stelo passante con ammortizzo regolabile non magnetico Double acting through rod with adjustable cushioning non magnetic					
CDEMAP	Doppio effetto stelo passante con ammortizzo regolabile magnetico Double acting through rod with adjustable cushioning magnetic					





## CORSE STANDARD STANDARD STROKES

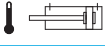
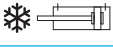

Ø (mm)	Corse standard (mm) Standard strokes (mm)													
160	10	25	40	50	80	100	125	160	200	250	300	320	400	500
200	10	25	40	50	80	100	125	160	200	250	300	320	400	500

## FORZE TEORICHE A 6 BAR THEORETICAL FORCES AT 6 BAR

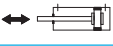
Ø (mm)	Forza di spinta (N) Thrust force (N)	Forza di trazione (N) Traction force (N)
160	12058	11304
200	18840	18086

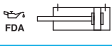
## VARIANTI VARIANTS

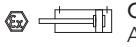
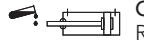
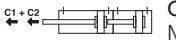
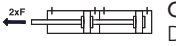
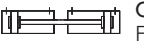
Simbolo Symbol	Caratteristiche Features
	Resistente alle alte temperature -10...+150°C Heat-resistant -10...+150°C
	Resistente alle basse temperature -40...+80°C Low temperature resistant -40...+80°C
	Stelo prolungato Piston rod extension
	Basso attrito Low friction
	Raschia stelo duro in poliestere Hard wiper in polyester
	Stelo in acciaio inox Stainless steel piston rod
	Lubrificazione FDA FDA lubrication

Simbolo Symbol	Caratteristiche Features
	Filettature e steli su richiesta Custom made thread or piston rod
	Certificazione ATEX ATEX certification
	Guarnizione stelo ad elevata resistenza chimica Rod seal with increased chemical resistance
	Configurazione tandem a più posizioni Multi position configuration
	Configurazione tandem a doppia spinta Double thrust tandem configuration
	Configurazione tandem contrapposti anteriore Front opposed tandem configuration
	Configurazione tandem contrapposti posteriore Rear opposed tandem configuration

# CILINDRI ISO15552 Ø160-200 ISO15552 CYLINDERS Ø160-200

**DOPPIO EFFETTO**  
**DOUBLE ACTING**

CDEØ/...X

CDEMØ/...X

CDEAØ/...X

CDEMAØ/...X

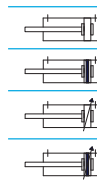
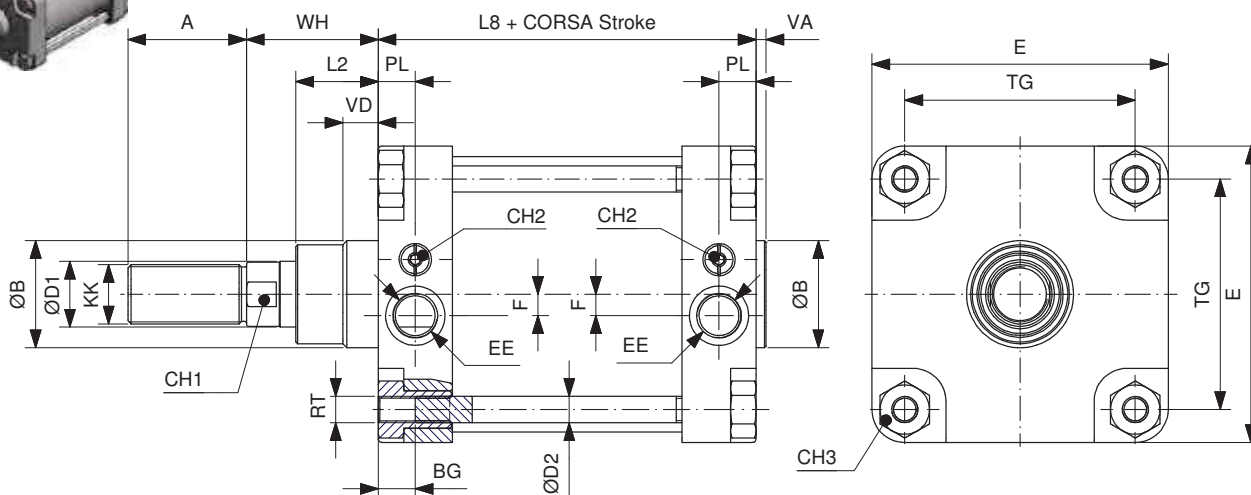

Ø	ØD1	ØD2	KK	A	ØB	VD	VA	L2	RT	BG	TG	EE	F	PL	WH	L8	E	CH1	CH2	CH3
160	40	16	M36X2	72	65	21.5	6	50	M16X2	24	140	3/4"G	13	22.5	80	179.5	180	36	6	30
200	40	16	M36X2	72	75	26.5	6	55	M16X2	24	175	3/4"G	13	22.5	95	180	220	36	6	30

**DOPPIO EFFETTO PASSANTE**  
**DOUBLE ACTING THROUGH PISTON ROD**

CDEPØ/...X

CDEMPØ/...X

CDEAPØ/...X

CDEMAPØ/...X

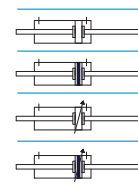
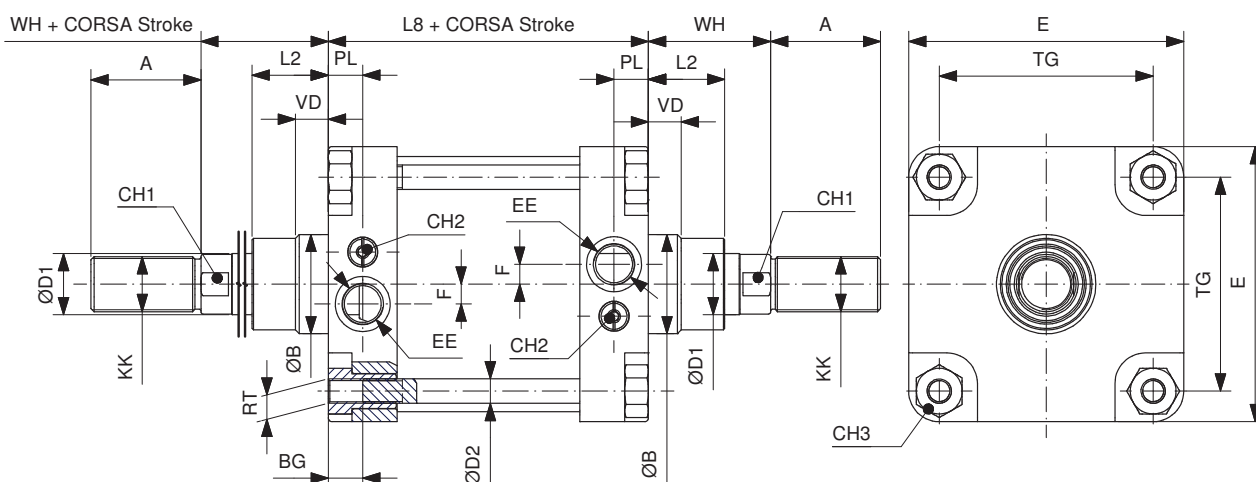

Ømm	ØD1	ØD2	KK	A	ØB	VD	L2	RT	BG	TG	EE	F	PL	WH	L8	E	CH1	CH2	CH3
160	40	16	M36X2	72	65	21.5	50	M16X2	24	140	3/4"G	13	22.5	80	179.5	180	36	6	30
200	40	16	M36X2	72	75	26.5	55	M16X2	24	175	3/4"G	13	22.5	95	180	220	36	6	30



## ACCESSORI DI FISSAGGIO MOUNTING ACCESSORIES

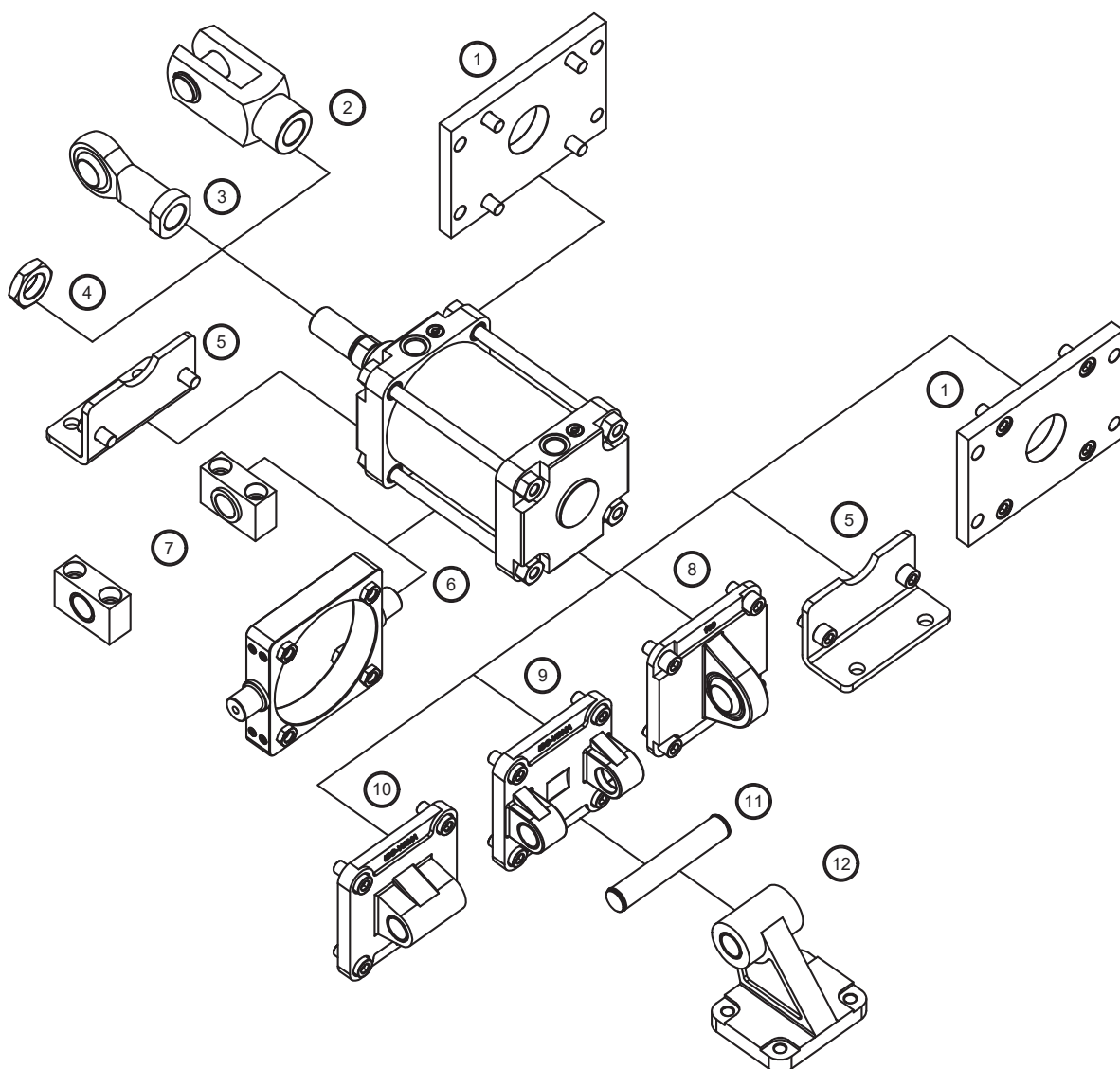

Descrizione Description	Alluminio Alluminium	Acciaio Steel	Acciaio inox Stainless steel
1 Flangia / Flange (MF1-MF2)	-	139	152
2 Forcella / Clevis	-	132	147
3 Testa a snodo / Rod end	-	132	148
4 Dado per aste / Piston rod nut	-	130	146
5 Piedino basso / Low-rise pedestal (MS1)	-	138	152
6 Cerniera intermedia per cilindri tirantati / Intermediate hinge for tie rods cylinders (MT4)	-	140	153
7 Supporto per cerniera intermedia / Support for intermediate hinge (AT4)	-	141	-
8 Cerniera maschio snodata / Male hinge with spherical bearing (MP6)	137	-	-
9 Cerniera femmina / Female hinge (MP2)	134	-	150
10 Cerniera maschio / Male hinge (MP4)	135	-	151
11 Perno per cerniera femmina / Pivot for female hinge (AA4)	-	135	150
12 Articolazione a squadra / Square joint (AB7)	137	-	-
13 Giunto autoallineante / Self-aligning joint	-	131	-

# CILINDRI ISO15552 Ø250-320 ISO 15552 CYLINDERS Ø250-320



Cilindri costruiti a norma ISO 15552 in versione con tiranti. Adatto ad applicazioni particolarmente gravose. Disponibili in versione magnetica o non, con o senza ammortizzo regolabile, a stelo singolo o passante. Ampia gamma di accessori. Su richiesta sono fornibili in varie esecuzioni speciali ed in versione conforme alla direttiva 2014/34/UE ATEX.

ISO 15552 cylinders, tie rods version. Suitable for heavy-duty applications. Available with or without magnet, with or without adjustable cushioning, single or through piston rod. Wide range of mounting accessories. Special versions are available. On request compliant with 2014/34/UE ATEX directive.

## VERSIONE VERSION

CDE		CDEP	
CDEM		CDEMP	
CDEA		CDEAP	
CDEMA		CDEMAP	

## INFORMAZIONI TECNICHE TECHNICAL INFORMATION

Testate Covers	Alluminio pressofuso verniciato Painted die-casted aluminium
Tubo Tube	Alluminio anodizzato Anodized aluminium
Pistone Piston	Alluminio Aluminium
Guarnizioni Seals	Poliuretano - NBR Polyurethane - NBR
Boccola guida Guiding bush	Bronzo sinterizzato Sintered bronze
Stelo Piston rod	Acciaio cromato Chromium coated steel
Tiranti Tie rods	Acciaio cromato Chromium coated steel
Pressione MAX MAX pressure	10 bar
Temperatura di impiego Working temperature	-20°C +80°C con aria secca -20°C +80°C with dry air
Fluido Working fluid	Aria compressa filtrata e lubrificata e non Filtered and lubricated or not compressed air

## CHIAVI DI CODIFICA CYLINDERS KEY CODE

Versione Version		Diametro Diameter	Corsa Stroke	Tipo costruttivo Design Type
CDEMA		250	100	X
CDE	Doppio effetto non magnetico Double acting non magnetic	250	0...2700	X ISO 15552 standard ISO 15552 standard
CDEM	Doppio effetto magnetico Double acting magnetic	320		
CDEA	Doppio effetto con ammortizzo regolabile non magnetico Double acting with adjustable cushioning non magnetic			
CDEMA	Doppio effetto con ammortizzo regolabile magnetico Double acting with adjustable cushioning magnetic			
CDEP	Doppio effetto stelo passante non magnetico Double acting through rod non magnetic			
CDEMP	Doppio effetto stelo passante magnetico Double acting through rod magnetic			
CDEAP	Doppio effetto stelo passante con ammortizzo regolabile non magnetico Double acting through rod with adjustable cushioning non magnetic			
CDEMAP	Doppio effetto stelo passante con ammortizzo regolabile magnetico Double acting through rod with adjustable cushioning magnetic			





## CORSE STANDARD STANDARD STROKES

Ø (mm)	Corse standard (mm) Standard strokes (mm)													
250	10	25	40	50	80	100	125	160	200	250	300	320	400	500
320	10	25	40	50	80	100	125	160	200	250	300	320	400	500

## FORZE TEORICHE A 6 BAR THEORETICAL FORCES AT 6 BAR

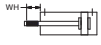
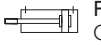
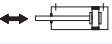
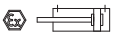
Ø (mm)	Forza di spinta (N) Thrust force (N)	Forza di trazione (N) Traction force (N)
250	29438	28260
320	48230	46361

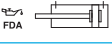
## VARIANTI VARIANTS

Simbolo Symbol	Caratteristiche Features	Simbolo Symbol	Caratteristiche Features
	Stelo prolungato Piston rod extension		Filettature e steli su richiesta Custom made thread or piston rod
	Basso attrito Low friction		Certificazione ATEX ATEX certification
	Raschia stelo duro in poliestere Hard wiper in polyester		Configurazione tandem contrapposti anteriore Front opposed tandem configuration
	Lubrificazione FDA FDA lubrication		Configurazione tandem contrapposti posteriore Rear opposed tandem configuration

# CILINDRI ISO15552 Ø250-320 ISO 15552 CYLINDERS Ø250-320

## DOPPIO EFFETTO DOUBLE ACTING

CDEØ/...X

CDEMØ/...X

CDEAØ/...X

CDEMAØ/...X

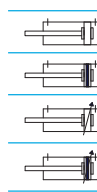
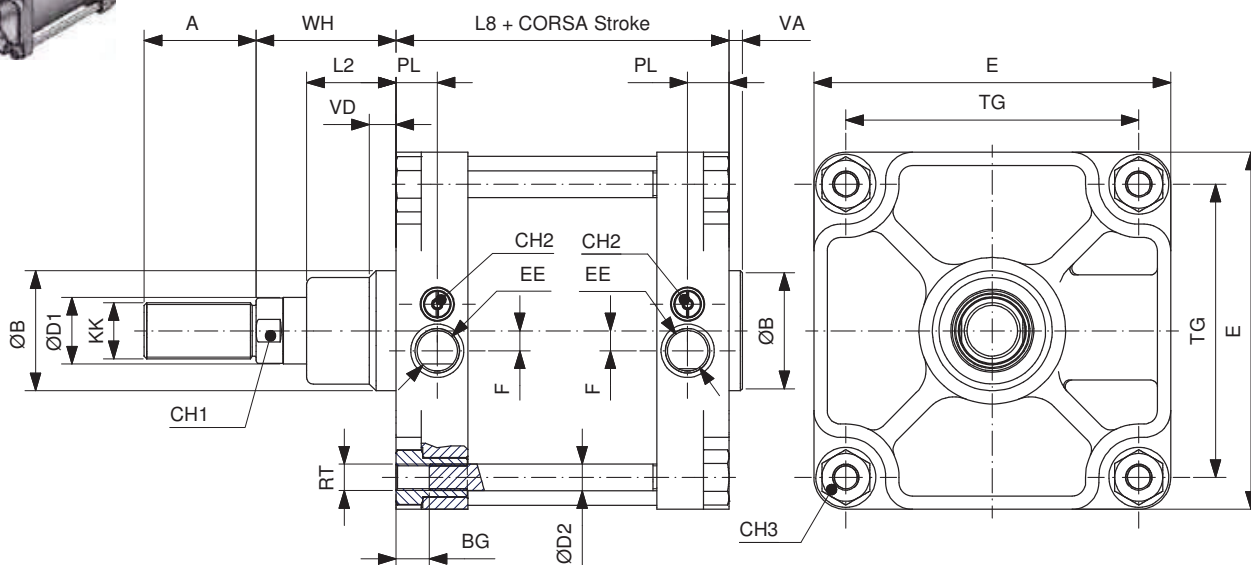

Ømm	ØD1	ØD2	KK	A	ØB	VD	VA	L2	RT	BG	TG	EE	F	PL	WH	L8	E	CH1	CH2	CH3
250	50	20	M42X2	84	90	20	10	67	M20X2.5	25	220	1"G	15	31	105	200	268	46	6	36
320	63	25	M48X2	96	110	20	10	82	M24X3	28	270	1"G	-	31	120	220	340	55	6	46

## DOPPIO EFFETTO PASSANTE DOUBLE ACTING THROUGH PISTON ROD

CDEPØ/...X

CDEMPØ/...X

CDEAPØ/...X

CDEMAPØ/...X

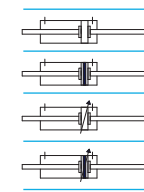
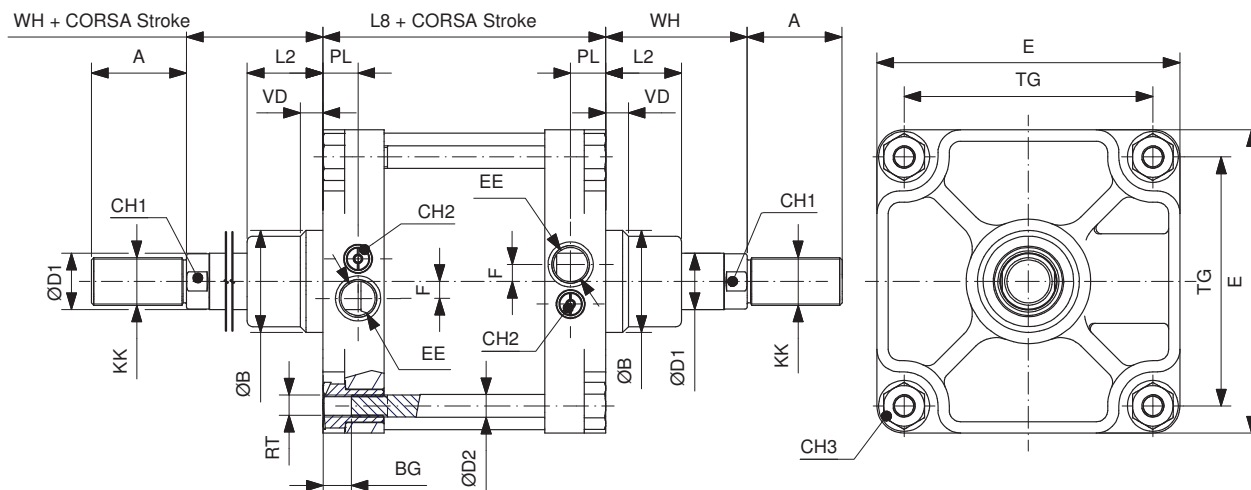

Ømm	ØD1	ØD2	KK	A	ØB	VD	L2	RT	BG	TG	EE	F	PL	WH	L8	E	CH1	CH2	CH3
250	50	20	M42X2	84	90	20	67	M20X2.5	25	220	1"G	15	31	105	200	268	46	6	36
320	63	25	M48X2	96	110	20	82	M24X3	28	270	1"G	-	31	120	220	340	55	6	46

## ACCESSORI DI FISSAGGIO MOUNTING ACCESSORIES

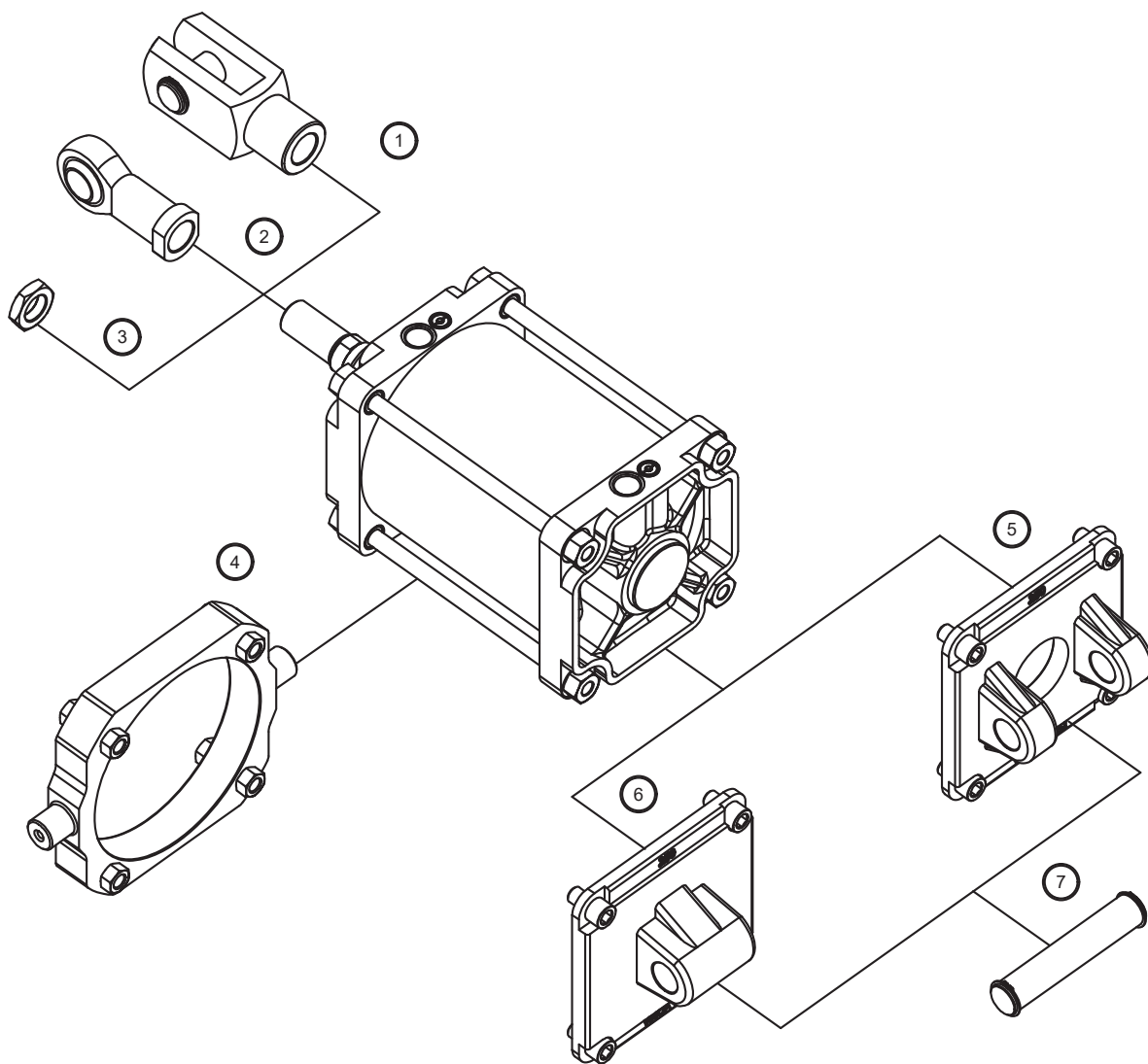

Descrizione Description	Alluminio Aluminium	Acciaio Steel
1 Forcella / Clevis	-	132
2 Testa a snodo / Rod end	-	132
3 Dado per aste / Piston rod nut	-	130
4 Cerniera intermedia per cilindri tirantati / Intermediate hinge for tie rods cylinders (MT4)	-	143
5 Cerniera femmina / Female hinge (MP2)	134	-
6 Cerniera maschio / Male hinge (MP4)	135	-
7 Perno per cerniera femmina / Pivot for female hinge (AA4)	-	135

# CILINDRI ISO 15552 INOX Ø32-125 ISO 15552 STAINLESS STEEL CYLINDERS Ø32-125



Cilindri costruiti a norma ISO 15552 in versione interamente inox. Caratterizzato dal design pulito e da grande resistenza e precisione di montaggio. Disponibili in versione magnetica o non, con o senza ammortizzo regolabile, a stelo singolo o passante. Ampia gamma di accessori. Su richiesta sono fornibili in varie esecuzioni speciali ed in versione conforme alla direttiva 2014/34/UE ATEX.

ISO 15552 cylinders, stainless steel version. Featuring a clean design, high resistance and mounting precision. Available with or without magnet, with or without adjustable cushioning, single or through piston rod. Wide range of mounting accessories. Special versions are available. On request compliant with 2014/34/UE ATEX directive.

## VERSIONE VERSION

CDE		CDEP	
CDEM		CDEMP	
CDEA		CDEAP	
CDEMA		CDEMAP	

Su richiesta disponibile in acciaio AISI316  
AISI316 stainless steel available on request

## INFORMAZIONI TECNICHE TECHNICAL INFORMATION

Testate Covers	Acciaio inox AISI304/AISI316 AISI304/AISI316 Stainless steel
Tubo Tube	Acciaio inox AISI304/AISI316 AISI304/AISI316 Stainless steel
Guarnizioni Seals	Poliuretano - NBR Polyurethane - NBR
Boccola guida Guiding bush	Bronzo sinterizzato Sintered bronze
Stelo Piston rod	Acciaio inox AISI316 AISI316 Stainless steel
Tiranti Tie rods	Ø32-Ø100 acciaio inox AISI316 Ø125 acciaio inox AISI304/AISI316 Ø32-Ø100 AISI316 stainless steel Ø125 AISI304/AISI316 stainless steel
Pressione MAX MAX pressure	10 bar
Temperatura di impiego Working temperature	-20°C +80°C con aria secca -20°C +80°C with dry air
Fluido Working fluid	Aria compressa filtrata e lubrificata e non Filtered and lubricated or not compressed air

## CHIAVI DI CODIFICA CYLINDERS KEY CODE

Versione Version		Diametro Diameter	Corsa Stroke	Tipo costruttivo Design Type		Guarnizioni Seals
CDEM		32	100	XF		V
CDE	Doppio effetto non magnetico Double acting non magnetic	32	0...2700	XF	ISO 15552 acciaio inox AISI304 ISO 15552 AISI304 stainless steel	- Standard
CDEM	Doppio effetto magnetico Double acting magnetic	40		XY	ISO 15552 acciaio inox AISI316 ISO 15552 AISI316 stainless steel	V Guarnizioni FKM FKM seals
CDEA	Doppio effetto con ammortizzo regolabile non magnetico Double acting with adjustable cushioning non magnetic	50				VG Guarnizione stelo FKM FKM rod seal
CDEMA	Doppio effetto con ammortizzo regolabile magnetico Double acting with adjustable cushioning magnetic	63				
CDEP	Doppio effetto stelo passante non magnetico Double acting through rod non magnetic	80				
CDEMP	Doppio effetto stelo passante magnetico Double acting through rod magnetic	100				
CDEAP	Doppio effetto stelo passante con ammortizzo regolabile non magnetico Double acting through rod with adjustable cushioning non magnetic	125				
CDEMAP	Doppio effetto stelo passante con ammortizzo regolabile magnetico Double acting through rod with adjustable cushioning magnetic					













## CORSE STANDARD STANDARD STROKES

Ø (mm)	Corse standard (mm) Standard strokes (mm)													
32	10	25	40	50	80	100	125	160	200	250	300	320	400	500
40	10	25	40	50	80	100	125	160	200	250	300	320	400	500
50	10	25	40	50	80	100	125	160	200	250	300	320	400	500
63	10	25	40	50	80	100	125	160	200	250	300	320	400	500
80	10	25	40	50	80	100	125	160	200	250	300	320	400	500
100	10	25	40	50	80	100	125	160	200	250	300	320	400	500
125	10	25	40	50	80	100	125	160	200	250	300	320	400	500

## FORZE TEORICHE A 6 BAR THEORETICAL FORCES AT 6 BAR

Ø (mm)	Forza di spinta (N) Thrust force (N)	Forza di trazione (N) Traction force (N)
32	482	414
40	754	633
50	1178	989
63	1869	1681
80	3014	2720
100	4710	4416
125	7359	6877

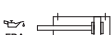
## VARIANTI VARIANTS

Simbolo Symbol	Caratteristiche Features	Simbolo Symbol	Caratteristiche Features
	Resistente alle alte temperature -10...+150°C Heat-resistant -10...+150°C		Certificazione ATEX ATEX certification
	Resistente alle basse temperature -40...+80°C Low temperature resistant -40...+80°C		Guarnizione stelo ad elevata resistenza chimica Rod seal with increased chemical resistance
	Stelo prolungato Piston rod extension		Configurazione tandem a più posizioni Multi position configuration
	Basso attrito Low friction		Configurazione tandem a doppia spinta Double thrust tandem configuration
	Raschia stelo duro in poliestere Hard wiper in polyester		Configurazione tandem contrapposti anteriore Front opposed tandem configuration
	Lubrificazione FDA FDA lubrication		Configurazione tandem contrapposti posteriore Rear opposed tandem configuration
	Filettature e steli su richiesta Custom made thread or piston rod		



# CILINDRI ISO 15552 INOX Ø32-125 ISO 15552 STAINLESS STEEL CYLINDERS Ø32-125

## DOPIO EFFETTO DOUBLE ACTING

CDEØ/...XF

CDEMØ/...XF

CDEAØ/...XF

CDEMAØ/...XF

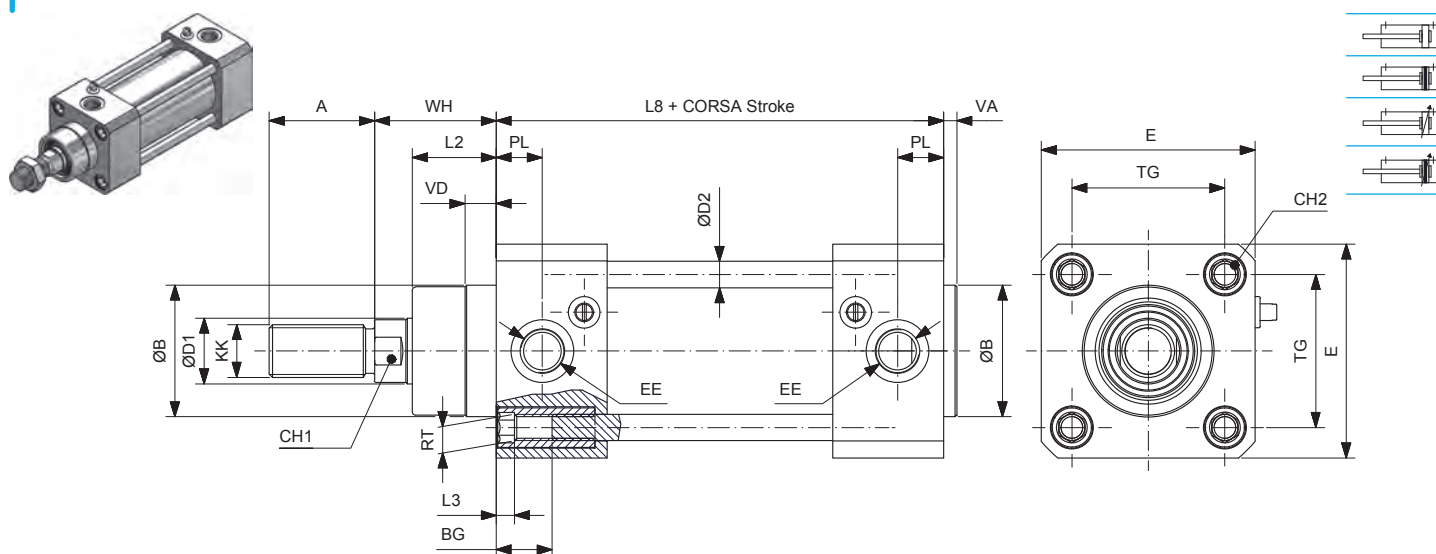

Ømm	ØD1	ØD2	KK	A	ØB	VD	VA	L2	RT	BG	L3	TG	EE	PL	WH	L8	E	CH1	CH2
32	12	6	M10x1.25	22	30	9.5	4	18	M6	16.5	5	32.5	1/8"G	13	26	94	50	10	6
40	16	6	M12x1.25	24	35	9.5	4	22	M6	16.5	5	38	1/4"G	14	30	105	55	13	6
50	20	8	M16x1.5	32	40	9.5	4	25.5	M8	17.5	5	46.5	1/4"G	14	37	106	65	17	8
63	20	8	M16x1.5	32	45	9.5	4	25	M8	17.5	5	56.5	3/8"G	16	37	121	75	17	8
80	25	10	M20x1.5	40	45	10	4	35	M10	17.5	-	72	3/8"G	17	46	128	95	22	-
100	25	10	M20x1.5	40	55	10	4	38	M10	17.5	-	89	1/2"G	18	51	138	110	22	-
125	32	12	M27x2	54	60	11	6	46	M12	20.5	-	110	1/2"G	18	65	160	140	27	-

## DOPIO EFFETTO PASSANTE DOUBLE ACTING THROUGH PISTON ROD

CDEPØ/...XF

CDEMPØ/...XF

CDEAPØ/...XF

CDEMAPØ/...XF

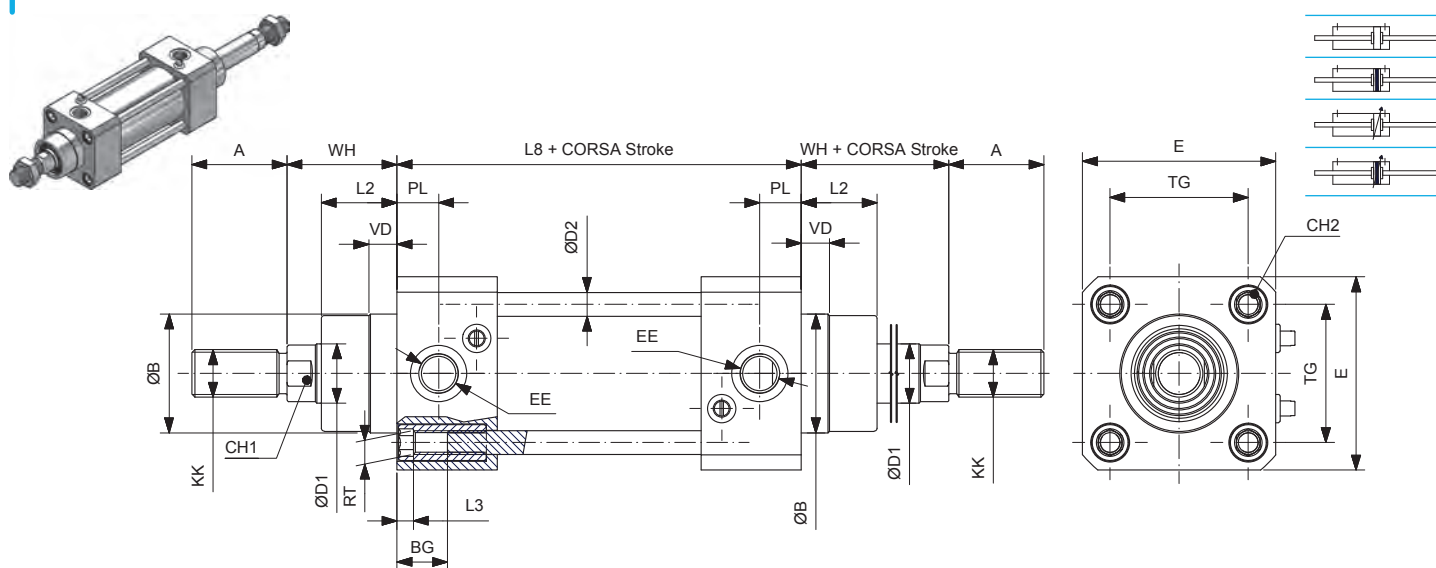

Ømm	ØD1	ØD2	KK	A	ØB	VD	L2	RT	BG	L3	TG	EE	PL	WH	L8	E	CH1	CH2
32	12	6	M10x1.25	22	30	9.5	18	M6	16.5	5	32.5	1/8"G	13	26	94	50	10	6
40	16	6	M12x1.25	24	35	9.5	22	M6	16.5	5	38	1/4"G	14	30	105	55	13	6
50	20	8	M16x1.5	32	40	9.5	25.5	M8	17.5	5	46.5	1/4"G	14	37	106	65	17	8
63	20	8	M16x1.5	32	45	9.5	25	M8	17.5	5	56.5	3/8"G	16	37	121	75	17	8
80	25	10	M20x1.5	40	45	10	35	M10	17.5	-	72	3/8"G	17	46	128	95	22	-
100	25	10	M20x1.5	40	55	10	38	M10	17.5	-	89	1/2"G	18	51	138	110	22	-
125	32	12	M27x2	54	60	11	46	M12	20.5	-	110	1/2"G	18	65	160	140	27	-

## ACCESSORI DI FISSAGGIO MOUNTING ACCESSORIES

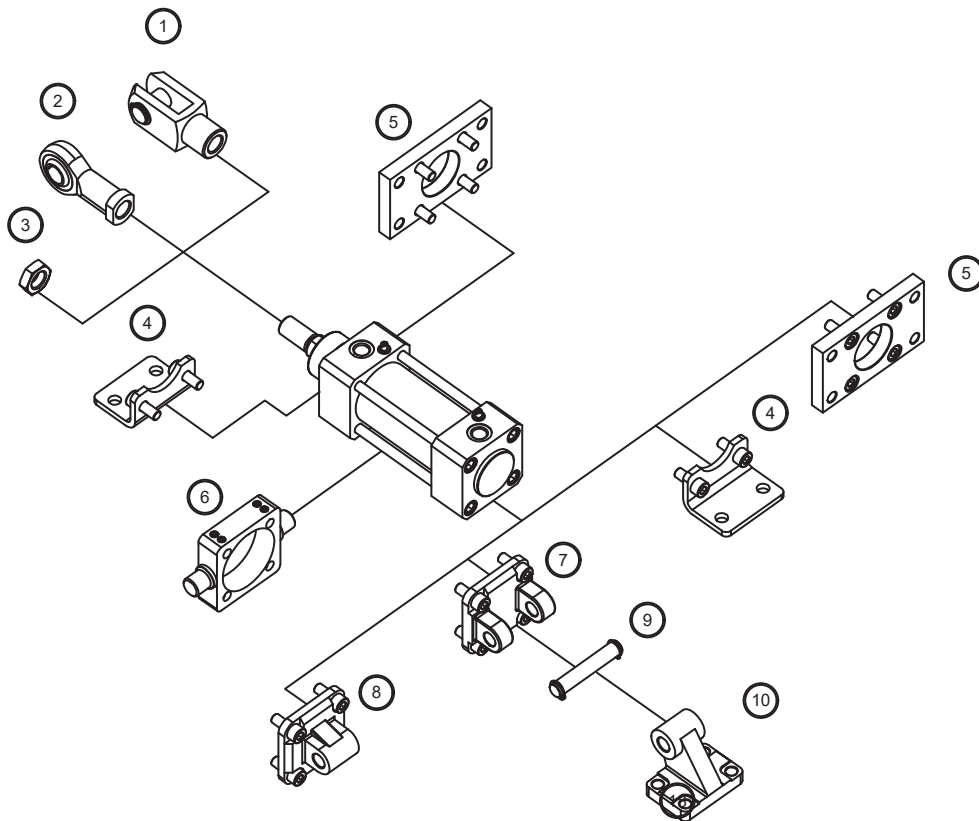

Descrizione Description	Acciaio inox Stainless steel
1 Forcella / Clevis	147
2 Testa a snodo / Rod end	148
3 Dado per aste / Piston rod nut	146
4 Piedino basso / Low-rise pedestal (MS1)	152
5 Flangia / Flange (MF1-MF2)	152
6 Cerniera intermedia per cilindri tiranti / Intermediate hinge for tie rods cylinders (MT4)	153
7 Cerniera femmina / Female hinge (MP2)	150
8 Cerniera maschio / Male hinge (MP4)	151
9 Perno per cerniera femmina / Pivot for female hinge (AA4)	150
10 Articolazione a squadra / Square joint (AB7)	151

# CILINDRI ISO 15552 INOX Ø160-200 ISO 15552 STAINLESS STEEL CYLINDERS Ø160-200

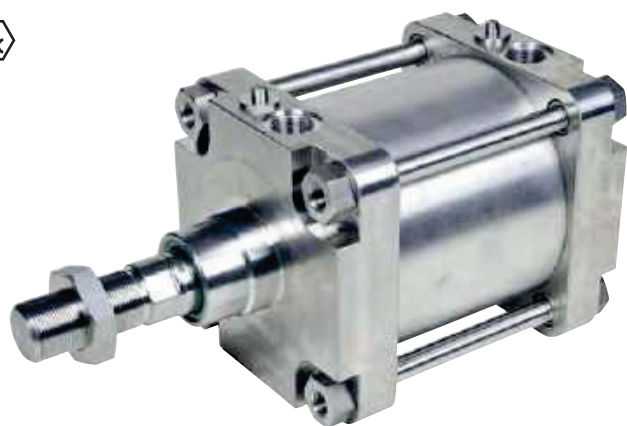

Cilindri costruiti a norma ISO 15552 in versione interamente inox. Caratterizzato dal design pulito e da grande resistenza e precisione di montaggio. Disponibili in versione magnetica o non, con o senza ammortizzo regolabile, a stelo singolo o passante. Ampia gamma di accessori. Su richiesta sono fornibili in varie esecuzioni speciali ed in versione conforme alla direttiva 2014/34/UE ATEX.

ISO 15552 cylinders, stainless steel version. Featuring a clean design, high resistance and mounting precision. Available with or without magnet, with or without adjustable cushioning, single or through piston rod. Wide range of mounting accessories. Special versions are available. On request compliant with 2014/34/UE ATEX directive.

## VERSIONE VERSION

CDE		CDEP	
CDEM		CDEMP	
CDEA		CDEAP	
CDEMA		CDEMAP	

## INFORMAZIONI TECNICHE TECHNICAL INFORMATION

Testate Covers	Acciaio inox AISI304 AISI304 Stainless steel
Tubo Tube	Acciaio inox AISI304 AISI304 Stainless steel
Guarnizioni Seals	Poliuretano - NBR Polyurethane - NBR
Boccola guida Guiding bush	Bronzo sinterizzato Sintered bronze
Stelo Piston rod	Acciaio inox AISI316 AISI316 Stainless steel
Tiranti Tie rods	Acciaio inox AISI304 AISI304 Stainless steel
Pressione MAX MAX pressure	10 bar
Temperatura di impiego Working temperature	-20°C +80°C con aria secca -20°C +80°C with dry air
Fluido Working fluid	Aria compressa filtrata e lubrificata e non Filtered and lubricated or not compressed air

## CHIAVI DI CODIFICA CYLINDERS KEY CODE

CDEM	160	100	XF	V
------	-----	-----	----	---

Versione Version		Diametro Diameter	Corsa Stroke	Tipo costruttivo Design Type	Guarnizioni Seals
CDE	Doppio effetto non magnetico Double acting non magnetic	160	0...2700	XF ISO 15552 standard ISO 15552 standard	- Standard
CDEM	Doppio effetto magnetico Double acting magnetic	200			V Guarnizioni FKM FKM seals
CDEA	Doppio effetto con ammortizzo regolabile non magnetico Double acting with adjustable cushioning non magnetic				VG Guarnizione stelo FKM FKM rod seal
CDEMA	Doppio effetto con ammortizzo regolabile magnetico Double acting with adjustable cushioning magnetic				
CDEP	Doppio effetto stelo passante non magnetico Double acting through rod non magnetic				
CDEMP	Doppio effetto stelo passante magnetico Double acting through rod magnetic				
CDEAP	Doppio effetto stelo passante con ammortizzo regolabile non magnetico Double acting through rod with adjustable cushioning non magnetic				
CDEMAP	Doppio effetto stelo passante con ammortizzo regolabile magnetico Double acting through rod with adjustable cushioning magnetic				











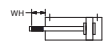

## CORSE STANDARD STANDARD STROKES

Ø (mm)	Corse standard (mm) Standard strokes (mm)													
160	10	25	40	50	80	100	125	160	200	250	300	320	400	500
200	10	25	40	50	80	100	125	160	200	250	300	320	400	500

## FORZE TEORICHE A 6 BAR THEORETICAL FORCES AT 6 BAR

Ø (mm)	Forza di spinta (N) Thrust force (N)	Forza di trazione (N) Traction force (N)
160	12058	11304
200	18840	18086

## VARIANTI VARIANTS

Simbolo Symbol	Caratteristiche Features	Simbolo Symbol	Caratteristiche Features
	Resistente alle alte temperature -10...+150°C Heat-resistant -10...+150°C		Certificazione ATEX ATEX certification
	Resistente alle basse temperature -40...+80°C Low temperature resistant -40...+80°C		Guarnizione stelo ad elevata resistenza chimica Rod seal with increased chemical resistance
	Stelo prolungato Piston rod extension		Configurazione tandem a più posizioni Multi position configuration
	Basso attrito Low friction		Configurazione tandem a doppia spinta Double thrust tandem configuration
	Raschia stelo duro in poliestere Hard wiper in polyester		Configurazione tandem contrapposti anteriore Front opposed tandem configuration
	Lubrificazione FDA FDA lubrication		Configurazione tandem contrapposti posteriore Rear opposed tandem configuration
	Filettature e steli su richiesta Custom made thread or piston rod		

# CILINDRI ISO 15552 INOX Ø160-200 ISO 15552 STAINLESS STEEL CYLINDERS Ø160-200

**DOPPIO EFFETTO**  
**DOUBLE ACTING**

CDEØ/...XF

CDEMØ/...XF

CDEAØ/...XF

CDEMAØ/...XF

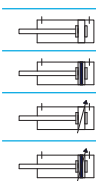
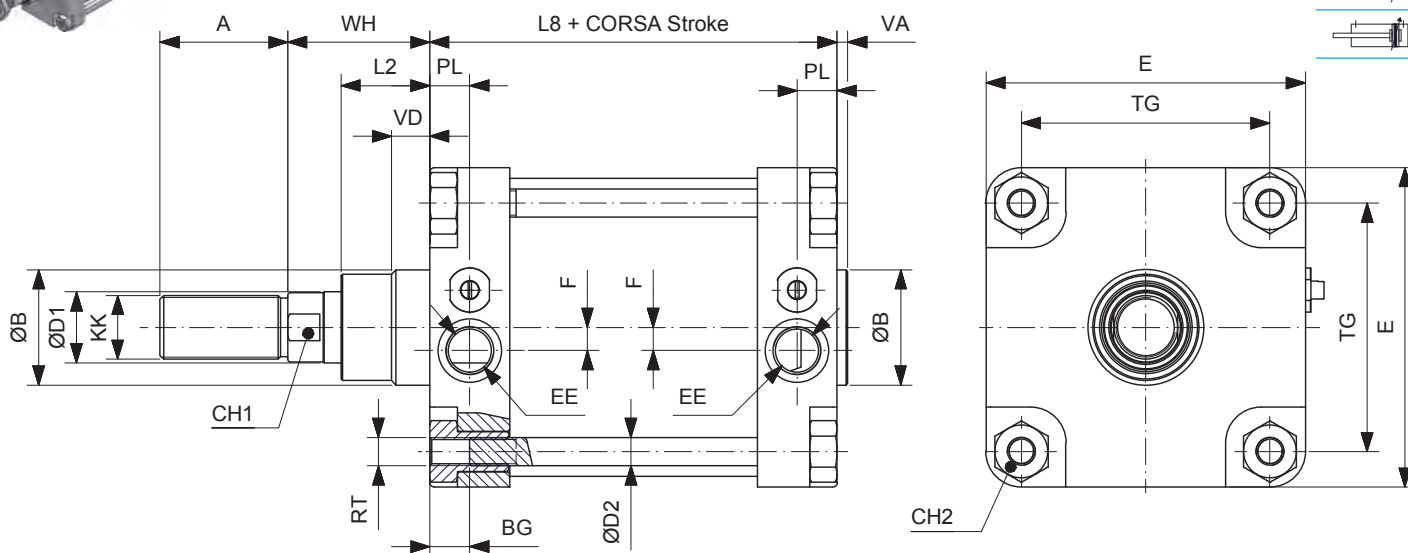

Ø mm	ØD1	ØD2	KK	A	ØB	VD	VA	L2	RT	BG	TG	EE	F	PL	WH	L8	E	CH1	CH2
160	40	16	M36X2	72	65	21.5	6	50	M16X2	24	140	3/4"G	13	22.5	80	179.5	180	36	30
200	40	16	M36X2	72	75	26.5	6	55	M16X2	24	175	3/4"G	13	22.5	95	180	220	36	30

**DOPPIO EFFETTO PASSANTE**  
**DOUBLE ACTING THROUGH PISTON ROD**

CDEPØ/...XF

CDEMPØ/...XF

CDEAPØ/...XF

CDEMAPØ/...XF

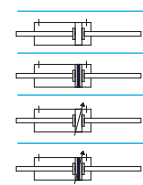
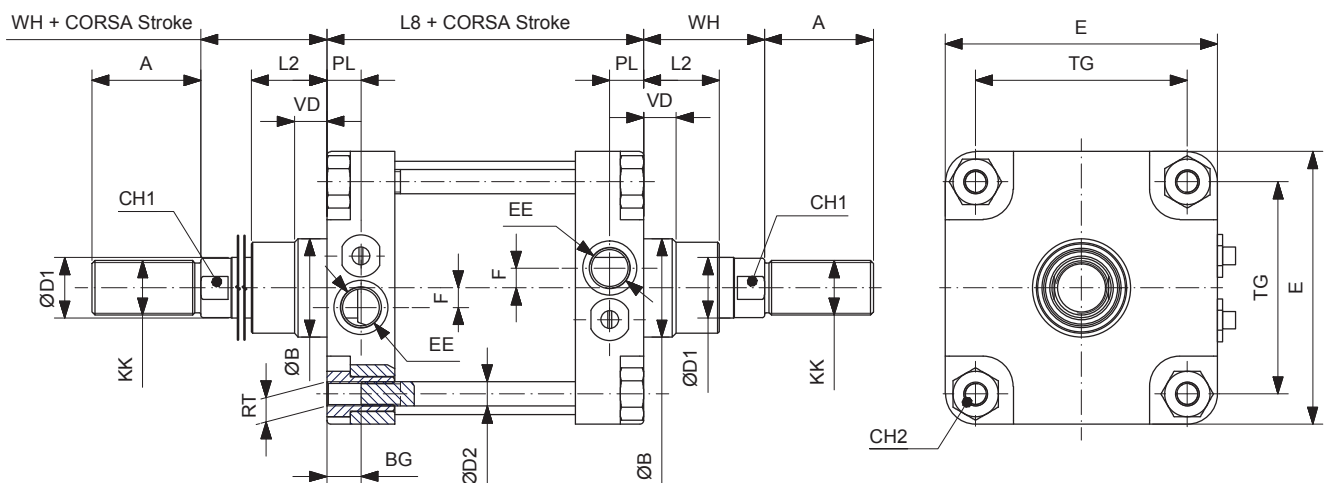

Ø mm	ØD1	ØD2	KK	A	ØB	VD	L2	RT	BG	TG	EE	F	PL	WH	L8	E	CH1	CH2
160	40	16	M36X2	72	65	21.5	50	M16X2	24	140	3/4"G	13	22.5	80	179.5	180	36	30
200	40	16	M36X2	72	75	26.5	55	M16X2	24	175	3/4"G	13	22.5	95	180	220	36	30

## ACCESSORI DI FISSAGGIO MOUNTING ACCESSORIES

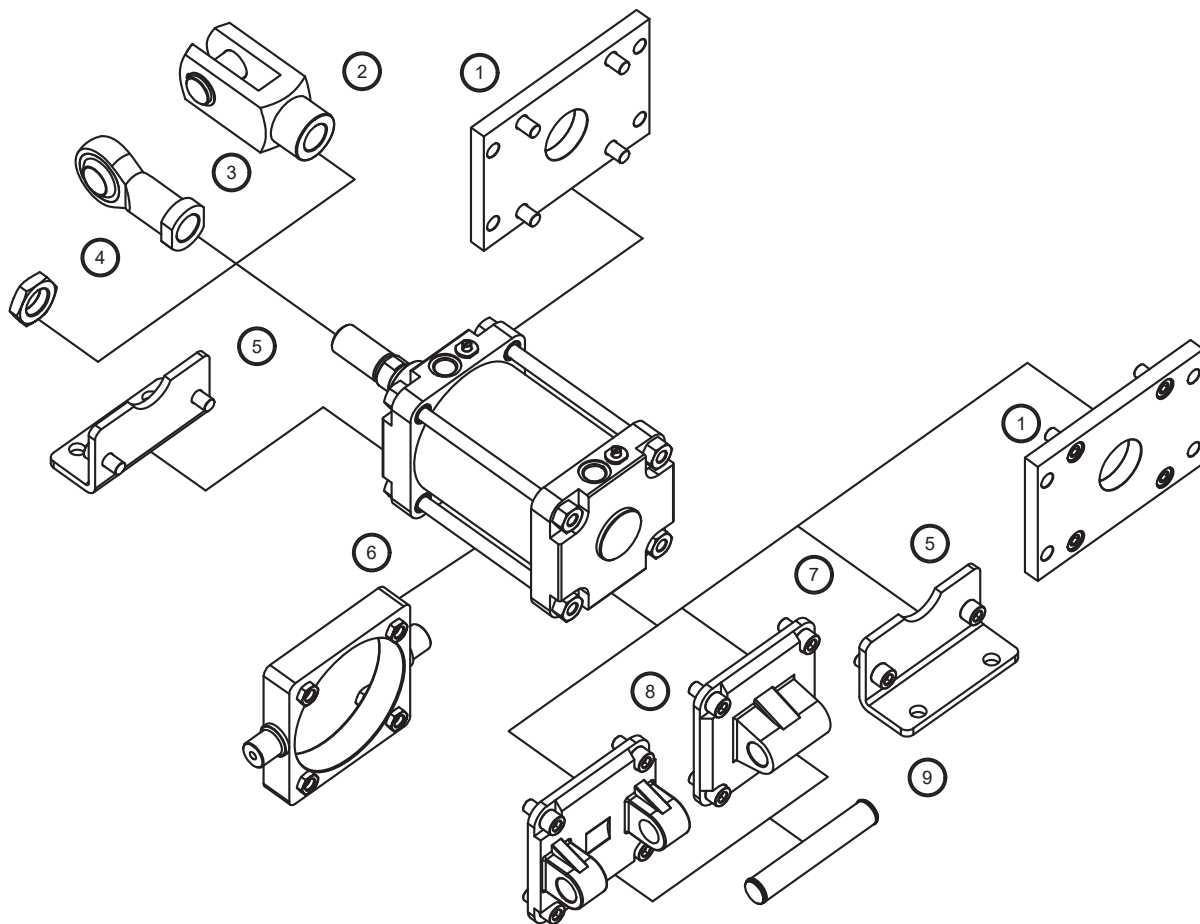

	Descrizione Description	Acciaio inox Stainless steel
1	Flangia / Flange (MF1-MF2)	152
2	Forcella / Clevis	147
3	Testa a snodo / Rod end	148
4	Dado per aste / Piston rod nut	146
5	Piedino basso / Low-rise pedestal (MS1)	152
6	Cerniera intermedia per cilindri tiranti / Intermediate hinge for tie rods cylinders (MT4)	153
7	Cerniera maschio / Male hinge (MP4)	151
8	Cerniera femmina / Female hinge (MP2)	150
9	Perno per cerniera femmina / Pivot for female hinge (AA4)	150