



RACCORDI AUTOMATICI MINIATURIZZATI

CARATTERISTICHE TECNICHE

I raccordi automatici rappresentano l'elemento di congiunzione tubo-attuatori per eccellenza. Pratico e veloce il raccordo automatico può essere riutilizzato migliaia di volte senza compromettere la perfetta tenuta pneumatica e meccanica. Disponibile in svariate configurazioni, assicura una flessibilità d'impiego praticamente illimitata; la molla di aggraffaggio, dal ricercato profilo, aggraffa il tubo senza inciderlo o deformarlo consentendo quindi una maggiore facilità nell'operazione di sgancio. Sui raccordi serie 700 da Ø 4 a Ø 12 (escluso Ø 5) la bussola per lo sgancio è dotata di spacchi per cacciavite (BREV.) per facilitare lo sgancio in applicazioni inaccessibili alle dita, inoltre le figure 719/T, 704/T, 705/T, 718/A, 726/T, 718/T, 716/T, 729/T (escluso Ø 5), presentano un anello per fissaggio a parete asimmetrico, in modo da contenere la testa di un'eventuale vite negli ingombri del raccordo.

MINIATURE PUSH-IN FITTINGS

TECHNICAL FEATURES

Push-in fittings are the best elements for connecting pipes and actuators. Quick and easy to use, the push-in fitting can be re-used thousands of times without affecting the pneumatic and mechanical seal in any way. It comes in various configurations and guarantees a virtually unlimited, highly flexible use. The clamping spring with its special shape grips the pipe without scratching or deforming it, which facilitates release. In the fittings, the release bushing has patented screwdriver slots to facilitate release in applications not accessible to the finger. Configurations 719/T, 704/T, 705/T, 718/A, 726/T, 718/T, 716/T, 729/T (except for Ø 5), have a ring for fixing to the wall asymmetrically in order to contain the head of a screw within the overall dimensions of the fitting.

DATI TECNICI	TECHNICAL DATA	
Attacco filettato	Threaded coupling	M3 - M5 - M7 - 1/8 - 1/4 - 3/8 - 1/2
Diametro	Diameter	mm Ø 3 - Ø 4 - Ø 5 - Ø 6 - Ø 8 - Ø 10 - Ø 12 - Ø 14
Range di temperatura raccordi in ottone	Temperature range for brass fittings	°C -20 °C + 80 °C
		°F -4 °F ÷ 162 °F
Range di temperatura raccordi in tecnopolimero	Temperature range for technopolymer fittings	°C -20 °C +60 °C
		°F -4 °F ÷ 140 °F
Range di pressione raccordi in ottone	Pressure range for brass fittings	-0,99 bar .. 16 bar / -0,099 MPa ... 1,6 MPa
Range di pressione raccordi in tecnopolimero	Pressure range for technopolymer fittings	-0,99 bar .. 12 bar / -0,099 MPa ... 1,2 MPa
Tubo consigliato	Recommended pipe	RilsanPA 11 - Nylon 6 - Poliammide 12 - Polipropilene RilsanPA 11 - Nylon 6 - RilsanPA 12 - Polypropylene
Fluido	Fluid	Vuoto - Aria compressa - Vuoto - Aria compressa Vacuum - Compressed air

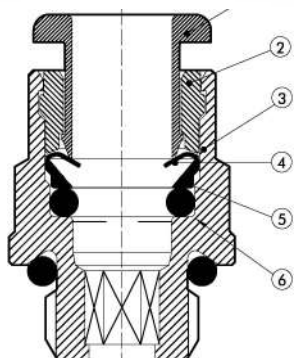

COMPONENTI

- ① Anello o bussola di sgancio - tecnopolimero
- ② Bussola di fermo: tecnopolimero
- ③ Corpo: ottone o tecnopolimero
- ④ Molla di aggraffaggio: acciaio inossidabile (per tubi Ø 3 e 731 Ø 5 e 732 Ø 5: pinza in ottone)
- ⑤ Anello di sostegno molla: tecnopolimero
- ⑥ Guarnizione di tenuta: NBR

COMPONENTS

- ① Ring or release bushing: technopolymer
- ② Locking bushing: brass or technopolymer
- ③ Body: brass or technopolymer
- ④ Clamping spring: stainless steel (for pipes Ø 3 and 731 Ø 5 and 732 Ø 5: brass gripper)
- ⑤ Spring supporting ring: technopolymer
- ⑥ Seal: NBR

TIPO DI AVVITATURA

SCREWING METHOD

Filetto - Thread	Coppia MAX - Max. Torque [Nm]
M3	0.4
M5	1.8
M7	2.5
M12x1.5	8
G 1/8	6
G 1/4	8
G 3/8	10
G 1/2	15

CH [mm]	Coppia MAX - Max. Torque [Nm]
1.5	0.4
2	0.7
2.5	1.2
3	2.5
4	5
5	8

Oltre 5 - Over 5 Vedi valori relativi ai filetti - See the values concerning threads

NB: Per l'avvitatura tramite chiave a brugola, il valore della coppia di serraggio da utilizzare non deve superare quello ammesso dal filetto (Esempio: il raccordo RL1 Ø 6 M7, che ha una chiave interna di 4 mm, va serrato con Max 2.5 Nm, valore limite del filetto)

NB: When using a socket spanner, the torque must not exceed that of the thread (e.g. fitting RL1 Ø 6 M7, with a 4 mm thread, has a maximum torque of 2.5 Nm, highest value of the thread)

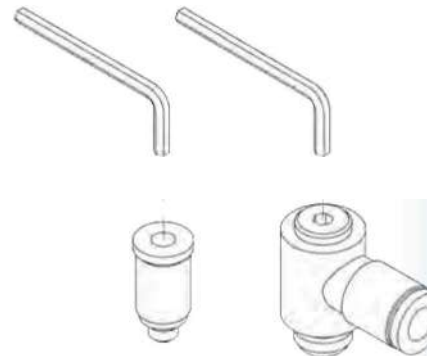
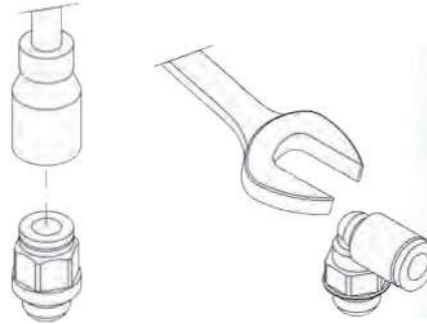

PDM

Cod.	Ø	F	Ch	Ch1	D	E	L	P	Conf.
PDM4-1/8	4	1/8	10	3	3.1	11.3	18.5	6.2	10
PDM6-1/8	6	1/8	12	4	4.1	13.5	22.5	6.2	10
PDM6-1/4	6	1/4	12	4	4.1	13.2	22.3	8.5	10
PDM8-1/8	8	1/8	13	6	6.2	14.3	26	6.2	10
PDM8-1/4	8	1/4	14	6	6.2	15.8	25.5	8.5	10
PDM8-3/8	8	3/8	14	6	6.2	16.6	24.9	9	10
PDM10-1/4	10	1/4	16	7	7.2	17.7	28.9	9.5	10
PDM10-3/8	10	3/8	16	8	8.2	17.7	26	9	10
PDM12-3/8	12	3/8	19	10	10.2	21	28.5	9	10
PDM12-1/2	12	1/2	19	10	10.2	21.3	26.6	11	10



- Diritto conico maschio
- Straight conical male

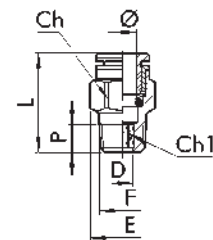

FDM

- Diritto cilindrico maschio (con OR di tenuta)
- Straight cyl male (with O-Ring)

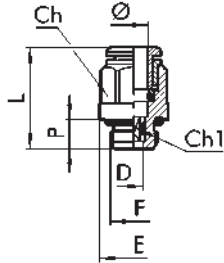

Cod.	Ø	F	Ch	Ch1	P	L	D	E	Conf.
FDM3-M3	3	M3	Ø 5.8	1.5	3	12.6	1.5	5.8	10
FDM3-M5	3	M5	Ø 5.8	2	3.5	13	2	5.8	10
FDM4-M5	4	M5	Ø 9	2.5	4	20.3	2.6	9	10
FDM4-M7	4	M7	Ø 9	3	5	18.9	3.1	9.8	10
FDM4-1/8	4	1/8	10	3	6	18	3.1	14	10
FDM4-1/4	4	1/4	10	3	8	19.8	3.1	18	10
FDM6-M5	6	M5	Ø 11	2.5	4	21.9	2.6	11	10
FDM6-M7	6	M7	Ø 11	4	5	23	4.1	11	10
FDM6-M12	6	M12x1.5	12	4	8	23.2	4.1	17	10
FDM6-1/8	6	1/8	12	4	6	21.6	4.1	14	10
FDM6-1/4	6	1/4	12	4	8	20.3	4.1	18	10
FDM8-M12	8	M12x1.5	14	6	8	24.5	6.2	17	10
FDM8-1/8	8	1/8	13	5	6	25.4	5.2	14	10
FDM8-1/4	8	1/4	14	6	8	24.4	6.2	18	10
FDM8-3/8	8	3/8	14	6	9	22.8	6.2	22	10
FDM10-1/4	10	1/4	16	7	8	29.2	7.2	18	10
FDM10-3/8	10	3/8	16	8	9	26.5	8.2	22	10
FDM10-1/2	10	1/2	16	8	11	29.8	8.2	26	10
FDM12-1/4	12	1/4	19	7	8	30.5	7.2	21	10
FDM12-3/8	12	3/8	19	10	9	28.1	10.2	22	10
FDM12-1/2	12	1/2	19	10	11	29.3	10.2	26	10
FDM14-3/8	14	3/8	22	10	9	33.8	10.2	24.6	10
FDM14-1/2	14	1/2	22	12	11	31.5	12.2	26	10

FDH

- Diritto femmina
- Straight female

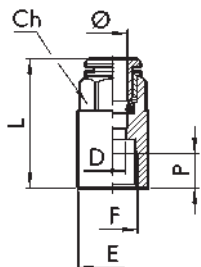

Cod.	Ø	F	Ch	P	L	D	E	Conf.
FDH4-1/8	4	1/8	10	7	26.2	3	14	10
FDH4-1/4	4	1/4	10	8	28.6	3	17	10
FDH6-1/8	6	1/8	12	7	27.1	5	14	10
FDH6-1/4	6	1/4	12	8	29.3	5	17	10
FDH8-1/8	8	1/8	13	7	28.1	7	14	10
FDH8-1/4	8	1/4	14	8	30	7	17	10
FDH10-1/4	10	1/4	16	8	31.8	8	17.7	10

FDI

Cod.	Ø1	Ø2	F	L	D	Conf.
FDI4	4	4	M11x1	30.6	2.5	10
FDI6	6	6	M13x1	33	4.5	10
FDI8	8	8	M15x1	35.7	6.5	10
FDI10	10	10	M17x1	39.2	8	10
FDI12	12	12	M20x1	40.7	10	10
FDI14	14	14	M24x1	45.9	12	10



- Diritto intermedio
- Straight intermediate

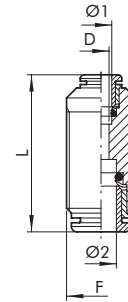

FDP

Cod.	Ø1	Ø2	F	Ch	L	D	I max	Conf.
FDP4	4	4	M11x1	13	30.6	2.5	11	10
FDP6	6	6	M13x1	16	33	4.5	12	10
FDP8	8	8	M15x1	17	35.7	6.5	13.5	10
FDP10	10	10	M17x1	20	39.2	8	17	10
FDP12	12	12	M20x1	24	40.7	10	20.3	10
FDP14	14	14	M24x1	27	45.9	12	21.9	10



- Diritto intermedio passalamiera
- Intermediate straight union for metal sheet flush mounting

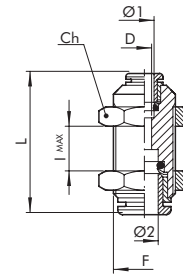

FTI

Cod.	Ø	L	L1	D	E	Conf.
E2L05001	4	16.7	33.4	2.5	9.5	10
E2L05003	6	19	38	4.5	11.5	10
E2L05004	8	21.3	42.6	6.5	13.5	10
E2L05005	10	23.3	46.6	8	16	10
E2L05006	12	26	52	10	20.5	10
E2L05007	14	29.3	58.6	12	22	10



- T intermedio
- Tee intermediate

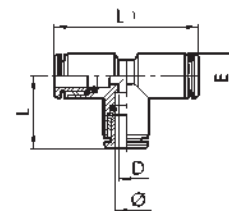

FCI

- L intermedio
- Elbow intermediate

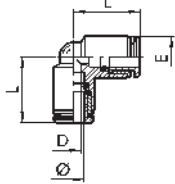

Cod.	Ø	L	D	E	Conf.
FCI4	4	16.7	2.5	9.5	10
FCI6	6	19	4.5	11.5	10
FCI8	8	21.3	6.5	13.5	10
FCI10	10	23.3	8	16	10
FCI12	12	26	10	20.5	10
FCI14	14	29.3	12	22	10

FCG

- L maschio girevole (con OR di tenuta)
- Rotary male elbow (with O-Ring)

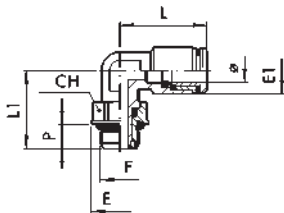

Cod.	Ø	F	Ch	E	E1	L	L1	P	Conf.
FCG4-M5	4	M5	9	9.9	9.5	18.6	15.3	4	10
FCG4-1/8	4	1/8	12	14	9.5	18.6	19.1	6	10
FCG4-1/4	4	1/4	14	18	9.5	18.6	21.1	8	10
FCG6-M5	6	M5	9	9.9	11.8	21.9	15.3	4	10
FCG6-1/8	6	1/8	12	14	11.8	21.9	19.1	6	10
FCG6-1/4	6	1/4	14	18	11.8	21.9	21.1	8	10
FCG8-1/8	8	1/8	12	14	13.5	25.4	19.1	6	10
FCG8-1/4	8	1/4	14	18	13.5	25.4	21.1	8	10
FCG8-3/8	8	3/8	17	22	13.8	23.6	27.1	9	10
FCG10-1/4	10	1/4	14	18	16	27.2	24.8	8	10
FCG10-3/8	10	3/8	17	22	16	27.2	27.1	9	10
FCG10-1/2	10	1/2	22	26	16	27.2	30.7	11	10
FCG12-1/4	12	1/4	14	18	20	30	25.6	8	10
FCG12-3/8	12	3/8	17	22	20	30	27.1	9	10
FCG12-1/2	12	1/2	22	26	20	30	30.7	11	10
FCG14-1/2	14	1/2	22	26	21.3	33	32.3	11	10

FCM

- L conico maschio
- Conical male elbow

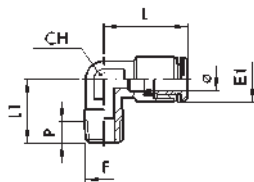

Cod.	Ø	F	Ch	E1	L	L1	P	Conf.
FCM4-1/8	4	1/8	10	9.5	18.6	16	6.2	10
FCM6-1/8	6	1/8	10	11.8	21.9	16	6.2	10
FCM6-1/4	6	1/4	10	11.8	21.9	18.5	8.5	10
FCM8-1/8	8	1/8	10	13.5	25.4	16	6.2	10
FCM8-1/4	8	1/4	10	13.5	25.4	18.5	8.5	10
FCM10-1/4	10	1/4	14	16	27.2	22	8.5	10

Cod.	Ø	F	Ch	E	E1	L	L1	P	Conf.
FTG4-1/8	4	1/8	12	14	9.5	37.2	19.1	6	10
FTG4-1/4	4	1/4	14	18	9.5	37.2	21.1	8	10
FTG6-1/8	6	1/8	12	14	11.8	43.8	19.1	6	10
FTG6-1/4	6	1/4	14	18	11.8	43.8	21.1	8	10
FTG8-1/8	8	1/8	12	14	13.5	50.8	19.1	6	10
FTG8-1/4	8	1/4	14	18	13.5	50.8	21.1	8	10
FTG8-3/8	8	3/8	17	22	13.8	47.2	27.1	9	10
FTG10-1/4	10	1/4	14	18	16	44.4	21.8	8	10
FTG10-3/8	10	3/8	17	22	16	44.4	27.1	9	10
FTG12-3/8	12	3/8	17	22	20	60	27.1	9	10
FTG12-1/2	12	1/2	22	26	20	60	30.7	11	10
FTG14-1/2	14	1/2	22	26	21.3	66	32.3	11	10

FTG



- T centrale maschio girevole (con OR di tenuta)
- Central rotary male tee (with O-Ring)

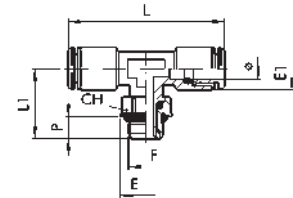

Cod.	Ø	F	Ch	E	E1	L	L1	P	Conf.
FTLG4-1/8	4	1/8	12	14	9.5	18.6	19.1	6	50
FTLG6-1/8	6	1/8	12	14	11.5	21.9	19.1	6	50
FTLG6-1/4	6	1/4	14	18	11.5	21.9	21.1	8	50
FTLG8-1/8	8	1/8	12	14	13.5	25.4	19.1	6	50
FTLG8-1/4	8	1/4	14	18	13.5	25.4	22.1	8	50
FTLG10-1/4	10	1/4	14	18	16	27.2	21.8	8	25
FTLG10-3/8	10	3/8	17	22	16	27.2	27.1	9	10
FTLG12-3/8	12	3/8	17	22	20	30	27.1	9	10
FTLG12-1/2	12	1/2	22	26	20	30	30.7	11	10

FTLG



- T laterale maschio girevole
- Side rotary male tee

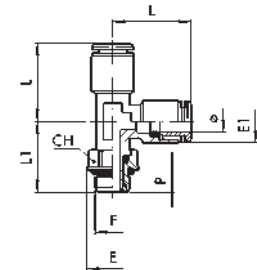

Cod.	Ø	D	E	L	L1	Conf.
FXI4	4	3	9.5	37.2	18.6	10
FXI6	6	4.5	11.3	43.8	21.9	10
FXI8	8	6.5	14	50.8	25.4	10

FXI



- Croce
- Cross

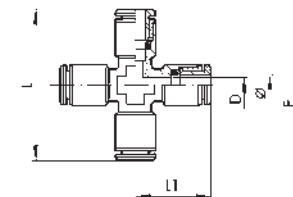

FCGA

- Asta maschio anello singolo girevole
- Rod, male single rotary ring

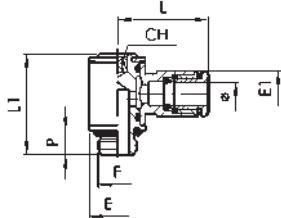

Cod.	Ø	F	Ch	P	L	L1	E	E1	Conf.
FCGA4-M5	4	M5	2	4	20.2	18.4	9.5	9.5	10
FCGA4-1/8	4	1/8	3	6	21.3	24.9	14	9.5	10
FCGA6-1/8	6	1/8	3	6	23	24.9	14	11.5	10
FCGA6-1/4	6	1/4	4	8	24.5	29.4	18	11.5	10
FCGA8-1/8	8	1/8	3	6	24.8	24.9	14	13.8	10
FCGA8-1/4	8	1/4	4	8	26.5	29.4	18	13.8	10
FCGA10-1/4	10	1/4	4	8	31.4	29.4	18	16.5	10
FCGA10-3/8	10	3/8	5	9	32.8	35.6	22	16	10

FCGDA

- Asta doppia anelli singoli girevole
- Dual-rod, single rotary rings

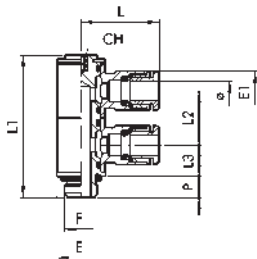

Cod.	Ø	F	CH	E	E1	L	L1	L2	L3	P	Conf.
FCGDA4-M5	4	M5	2	9.5	9.5	20.2	30.3	11.5	6.8	4	10
FCGDA4-1/8	4	1/8	3	14	9.5	20.2	40.9	15.5	9.1	6	10
FCGDA6-1/8	6	1/8	3	14	11.3	23.5	40.9	15.5	9.1	6	10
FCGDA6-1/4	6	1/4	4	18	11.5	23	47	17.2	10.2	8	10
FCGDA8-1/8	8	1/8	3	14	13.8	24.8	40.9	15.5	9.1	6	10
FCGDA8-1/4	8	1/4	4	18	13.8	26.5	47	17.2	10.2	8	10
FCGDA10-1/4	10	1/4	4	18	16.5	31.4	47	17.2	10.2	8	10

FTGA

Cod.	Ø	F	Ch	P	L	L1	E	E1	Conf.
FTGA4-M5	4	M5	2	4	40.4	18.4	9.5	9.5	10
FTGA4-1/8	4	1/8	3	6	42.6	24.9	14	9.5	10
FTGA6-1/8	6	1/8	3	6	46	24.9	14	11.5	10
FTGA6-1/4	6	1/4	4	8	49	29.4	18	11.5	10
FTGA8-1/8	8	1/8	3	6	49.6	24.9	14	13.8	10
FTGA8-1/4	8	1/4	4	8	53	29.4	18	13.8	10
FTGA10-1/4	10	1/4	4	8	62.8	29.4	22	16.5	10



- Asta maschio anello doppio girevole
- Rod, male dual rotary ring

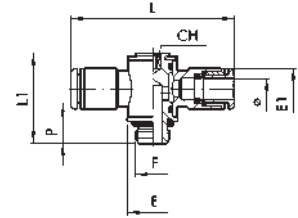

Cod.	Ø	F	CH	E	E1	L	L1	L2	L3	P	Conf.
FTGDA4-M5	4	M5	2	9.5	9.5	40.4	30.3	11.5	6.8	4	10
FTGDA4-1/8	4	1/8	3	14	9.5	40.4	40.9	15.5	9.1	6	10
FTGDA6-1/8	6	1/8	3	14	11.3	47	40.9	15.5	9.1	6	10
FTGDA6-1/4	6	1/4	4	18	11.5	46	47	17.2	10.2	8	10
FTGDA8-1/8	8	1/8	3	14	13.8	49.6	40.9	15.5	9.1	6	10
FTGDA8-1/4	8	1/4	4	18	13.8	53	47	17.2	10.2	8	10



FTGDA

- Asta doppia anelli doppi girevoli
- Dual-rod, double rotary rings

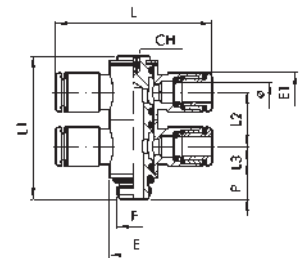

FTO

Cod.	Ø	F	CH	E	E1	L	L1	P	Conf.
FTO4-M5	4	M5	9	9.5	9.5	40.4	18.7	4.5	10
FTO4-1/8	4	1/8	13	14	9.5	42.6	25.3	6	10
FTO6-M5	6	M5	9	9.5	11.3	47	18.7	4.5	10
FTO6-1/8	6	1/8	13	14	11.5	46	25.3	6	10
FTO6-1/4	6	1/4	16	18	11.5	49	29.2	8	10
FTO8-1/8	8	1/8	13	14	13.8	49.6	25.3	6	10
FTO8-1/4	8	1/4	16	18	13.8	53	29.2	8	10
FTO8-3/8	8	3/8	20	21	13.8	57	35.4	9	10
FTO10-1/4	10	1/4	16	18	16.5	62.8	29.2	8	10
FTO10-3/8	10	3/8	20	21	16	65.6	35.4	9	10
FTO12-3/8	12	3/8	20	21	19.5	70.6	35.4	9	10
FTO12-1/2	12	1/2	25	26	19.5	74	40	11	10



- Asta maschio anello doppio orientabile
- Male-rod, double adjustable ring

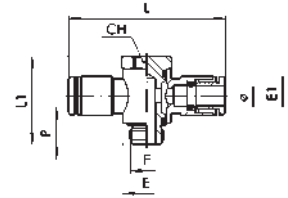

Cod.	Ø	F	CH	E	E1	L	L1	L2	L3	P	Conf.
FTOD4-M5	4	M5	9	9.5	9.5	40.4	30.2	11.5	5.8	4.5	10
FTOD4-1/8	4	1/8	13	14	9.5	42.6	41	15.5	7.8	6	10
FTOD6-M5	6	M5	9	9.5	11.3	47	30.2	11.5	5.8	4.5	10
FTOD6-1/8	6	1/8	13	14	11.5	46	41	15.5	7.8	6	10
FTOD6-1/4	6	1/4	16	18	11.5	49	46.4	17.2	8.6	8	10
FTOD8-1/8	8	1/8	13	14	13.8	49.6	41	15.5	7.8	6	10
FTOD8-1/4	8	1/4	16	18	13.8	53	46.4	17.2	8.6	8	10



FTOD

- Asta doppia maschio anelli doppi orientabili
- Male dual-rod, double adjustable rings

