

LINEA 039 1/8"-1/4" | ACCESSORI E RICAMBI

MANOMETRO

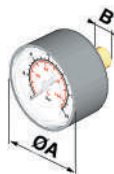

CODICE	Bar	Psi	A	B	CH.
A38.00.00026	0-12	0-175	40	G1/8"	14
A38.00.00055	0-6	0-85	40	G1/8"	12
A38.00.00114	0-2,5	0-36	40	G1/8"	12

STAFFA FISSAGGIO A PARETE

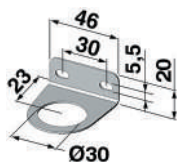

CODICE
C38.00.00069

GRANO G1/8"



CODICE	LINEA
B38.00.00018	038 - 039

MOLLA REGOLAZIONE



CODICE	LINEA	CAMPO DI REGOLAZIONE
A38.00.00133	039	0-1 Bar
A38.00.00132	039	0-2 Bar
A38.00.00131	039	0-4 Bar
A38.00.00130	039	0-8 Bar
A38.00.00129	039	0-10 Bar
A38.00.00128	039	0-12 Bar

GRUPPO MEMBRANA COMPLETO

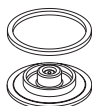

CODICE	LINEA	VERSIONE
C39.00.00074	039	RELIEVING
C39.00.00075	039	NON RELIEVING
C39.00.00076	039	FA-RM
C39.00.00077	039 INOX	NON RELIEVING
C39.00.00086	039 POM	NON RELIEVING
C39.00.00094	039 EPDM	RELIEVING
C39.00.00095	039 EPDM	NON RELIEVING

TRATTAMENTO ARIA

VALVOLE

CILINDRI

RACCORDI

TRATTAMENTO ACQUA

LINEA 035 1/8" | ACCESSORI E RICAMBI

MANOMETRO

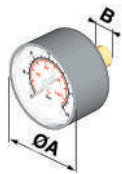

CODICE	Bar	Psi	A	B	CH.
A35.01.00035	0-6	-	25	G1/8"	11
A35.01.00025	0-12	0-175	25	G1/8"	11

GRANO G1/8"



CODICE	PRODOTTO
B38.00.00018	MR - MR P

KIT ASSEMBLAGGIO PER GRUPPI



CODICE	PRODOTTO
C35.01.00018	MR - F - MF

MOLLA REGOLAZIONE



CODICE	LINE	CAMPO REGOLAZIONE
A35.01.00006	035	0-6 Bar

GRUPPO MEMBRANA CON VALVOLA

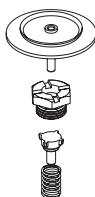

CODICE	PRODOTTO	VERSIONE
C38.00.00049	MR	RELIEVING
C38.00.00050	MR - MR P	NON RELIEVING

GRUPPO FILTRAGGIO

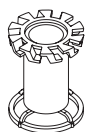

CODICE	PRODOTTO	VERSIONE
C35.02.00006	F	20 Micron
C35.02.00010	F	5 Micron
C35.02.00005	F	80 Micron

TAZZA COMPLETA PER FILTRO

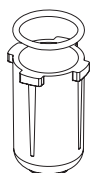

CODICE	PRODOTTO	VERSIONE
C35.02.00004	F - MF	SS
C35.03.00001	F	Per acqua

LINEA 042 1/4" | ACCESSORI

MANOMETRO

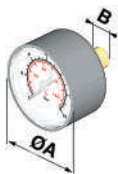

CODICE	Bar	Psi	A	B	CH.
A38.00.00026	0-12	0-175	40	G1/8"	14
A38.00.00055	0-6	0-85	40	G1/8"	12
A38.00.00114	0-2,5	0-36	40	G1/8"	12

MANOMETRO COMPATTO

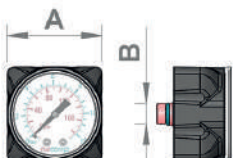

CODICE	Bar	Psi	A	B
A42.01.00021	0-12	0-175	40	G1/8"

GRANO G1/8"



CODICE	CONNESSIONE
B38.00.00018	G1/8"
A42.01.00010	G1/4" (air takeoff)

STAFFA FISSAGGIO A PARETE

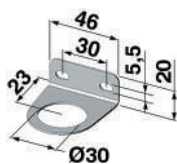

CODICE	PRODOTTO
C38.00.00069	MR-R-FR

KIT STAFFA DI FISSAGGIO A "T"

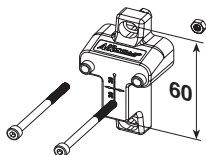

CODICE	PRODOTTO
C42.05.00001	TUTTI

KIT PER ASSEMBLAGGIO UNITÀ



CODICE	PRODOTTO
C40.06.00001	FR+L
	F+MF+CF

SLIM KIT PER ASSEMBLAGGIO BATTERIE

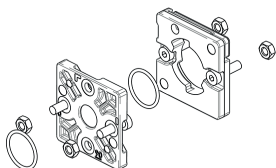

CODICE	PRODOTTO
C42.06.00007	TUTTI

LINEA 042 1/4" | ACCESSORI

PRESA D'ARIA INTERMEDIA PER UNITÀ

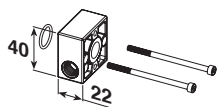

CODICE	CONNESSIONE	PRODOTTO
C40.05.00108	1/4"	F+R+L - FR+L V3+FR+L - F+L - F+MF
C40.05.00103	2 WAYS (1/4"-1/8")	F+R+L - FR+L V3+FR+L - F+L - F+MF

PRESA D'ARIA INTERMEDIA SLIM PER BATTERIE

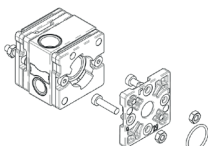

CODICE	CONNESSIONE	PRODOTTO
C42.05.00018	1/4 - 1/8	TUTTI

PRESA D'ARIA INGRESSO

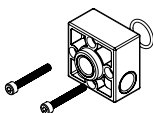

CODICE	CONNESSIONE	PRODOTTO
C42.06.00002	G1/4"- G1/4"	TUTTI

PRESA D'ARIA USCITA

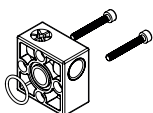

CODICE	CONNESSIONE	PRODOTTO
C42.06.00003	G1/4"- G1/4"	TUTTI

SCARICO AUTOMATICO



CODICE	PROD.
C40.02.00130 SA	F - FR - MF
C42.02.00012 SAD	F - FR - MF

KIT MONTAGGIO SCARICO AUTOMATICO

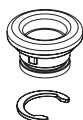

CODICE	PROD.
C40.02.00131	SA - SAD

PRESSOSTATO



CODICE	REF.
A50.06.00005	AP1 - 3-02-03-G

Per maggiori informazioni relative al pressostato ed alle prese d'aria con pressostato vedi pag. 1.138

TRATTAMENTO ARIA

VALVOLE

CILINDRI

RACCORDI

TRATTAMENTO ACQUA

LINEA 042 1/4" | RICAMBI

GRUPPO FILTRAGGIO

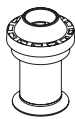

CODICE	PRODOTTO	VERSIONE
C40.02.00101	F	20 MICRON
C42.04.00001	FR	20 MICRON
C40.02.00106	F	5 MICRON
C42.04.00005	FR	5 MICRON
C40.02.00053	MF	0,01 MICRON
A42.02.00009	CF	CARBON

GRUPPO MEMBRANA COMPLETO

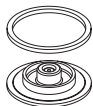

CODICE	PRODOTTO	VERSIONE
C39.00.00074	R - FR	RELIEVING
C39.00.00075	R - FR	NON RELIEVING
C39.00.00076	R - FR	FA-RM

MOLLA REGOLAZIONE



CODICE	PRODOTTO	CAMPO REGOLAZIONE
A38.00.00131	F - FR - MF	0-4 Bar
A38.00.00130	F - FR - MF	0-8 Bar
A38.00.00129	F - FR - MF	0-10 Bar
A38.00.00128	F - FR - MF	0-12 Bar

TAZZA COMPLETA PER FILTRO



CODICE	PRODOTTO	VERSIONE
C40.02.00062	F - FR - MF	TT SS
C40.02.00108	F - FR - MF	PE SS
C40.02.00036	F - FR - MF	TC SS

TAZZA CON SCARICO AUTOMATICO



CODICE	PRODOTTO	VERSIONE
C40.02.00133	F - FR - MF	TT SA
C40.02.00134	F - FR - MF	PE SA
C42.02.00017	F - FR - MF	TC SAD
C42.02.00014	F - FR - MF	PE SAD

TAZZA COMPLETA PER LUBRIFICATORE



CODICE	PRODOTTO	VERSIONE
C40.03.00082	L	TT
C40.03.00084	L	PE
C40.03.01016	VL	TT
C40.03.01017	VL	PE
C40.03.00047	L	TC

CUPOLA SPIA COMPLETA



CODICE	PRODOTTO
C42.03.00005	L

TAPPO OLIO CON OR 2031



CODICE	PRODOTTO
C75.03.00073	L

LINEA 050 3/8-052 1/2 | ACCESSORI

MANOMETRO

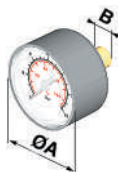

CODICE	Bar	Psi	A	B	CH.
A38.00.00026	0-12	0-175	40	G1/8"	14
A38.00.00055	0-6	0-85	40	G1/8"	12
A38.00.00114	0-2,5	0-36	40	G1/8"	12

MANOMETRO COMPATTO

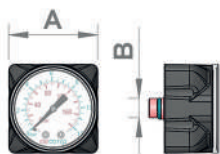

CODICE	Bar	Psi	A	B
A75.01.00045	0-12	0-175	50	G1/8"

STAFFA FISSAGGIO A PARETE

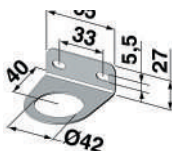

CODICE
C75.01.00018

KIT STAFFA A "T" SERIE 050 - 052



CODICE
C50.06.00006

KIT PER ASSEMBLAGGIO GRUPPI

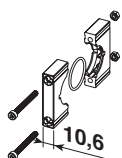

CODICE	PROD.
C50.05.00001	F+R+L
C50.06.00001	FR+L - F+L

PRESA D'ARIA

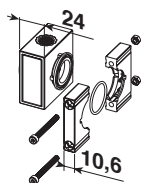

CODICE	CONNECTION	PROD.
Presa d'aria intermedia		
C50.05.00003	1/4"	F+R+L - FR+L - F+L
Presa d'aria ingresso		
C50.06.00002	1/4"- 3/8"	tutti / all
Presa d'aria uscita		
C50.06.00003	1/4"- 3/8"	tutti / all

GRANO G1/8"



CODICE	PRODUCT
B38.00.00018	G1/8"
A42.01.00010	G1/4" (air takeoff)

TRATTAMENTO ARIA

VALVOLE

CILINDRI

RACCORDI

TRATTAMENTO ACQUA

LINEA 050 3/8-052 1/2 | ACCESSORI

PRESSOSTATO



CODICE	REF.
A50.06.00005	API - 3-02-03-G

Per maggiori informazioni sul pressostato consulta la pagina dedicata

PRESA D'ARIA INTERMEDIA CON PRESSOSTATO LINEA 050-052



CODICE	REF.
C50.05.00006	PA 050 INTERMEDIA + API

PRESA D'ARIA TERMINALE CON PRESSOSTATO LINEA 050-052 - 3/8



CODICE	REF.
C50.05.00007	PA INGRESSO 050 3/8 + API (INLET)
C50.05.00008	PA USCITA 050 3/8 + API (OUTLET)

SCARICO AUTOMATICO



CODICE	PRODUCT
C40.02.00130 SA	F - FR - MF
C42.02.00012 SAD	F - FR - MF

KIT MONTAGGIO SCARICO AUTOMATICO



CODICE	PRODUCT
C40.02.00131	SA - SAD

LINEA 050 3/8-052 1/2 | RICAMBI

GRUPPO MEMBRANA COMPLETO

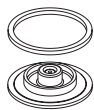

CODICE	PROD.	VERSION
C50.01.00021	R - FR	RELIEVING

MOLLA REGOLAZIONE



CODICE	PROD	SET REGULATION
A50.01.00006	MR - R - FR	0-4 Bar
A50.01.00007	MR - R - FR	0-8 Bar
A50.01.00008	MR - R - FR	0-12 Bar

TAZZA COMPLETA PER FILTRO

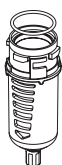

CODICE	PROD.	VERSION
C50.02.00002	F - FR - MF	PE SS
C50.02.00038	F - FR - MF	PE SA
C50.02.00062	F - FR - MF	PE SAD

TAZZA COMPLETA PER LUBRIFICATORE

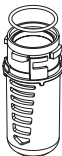

CODICE	PROD.	VERSION
C50.03.00001	L	PE
C50.13.01000	VL	PE
C50.03.00038	IL	PE

CUPOLA SPIA COMPLETA



CODICE	PROD.
C42.03.00005	L

TAPPO OLIO CON OR 2031

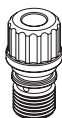

CODICE	PROD.
C75.03.00073	L

GRUPPO FILTRAGGIO

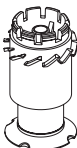

CODICE	PROD.	VERSION
C50.02.00005	F	20 MICRON
C50.02.00018	FR	20 MICRON
C50.02.00006	F	5 MICRON
C50.02.00019	FR	5 MICRON
C50.02.00007	MF	0,01 MICRON
A50.02.00009	CF	CARBON

TRATTAMENTO ARIA

VALVOLE

CILINDRI

RACCORDI

TRATTAMENTO ACQUA

LINEA 075 1/2 | ACCESSORI

MANOMETRO

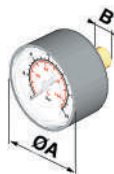

CODICE	Bar	Psi	A	B	CH.
A75.01.00010	0-12	0-175	50	G1/8"	14
A75.01.00011	0-6	0-85	50	G1/8"	14

MANOMETRO COMPATTO



CODICE	Bar	Psi	A	B
A750100045	0-12	0-175	50	G1/8"

STAFFA FISSAGGIO A PARETE

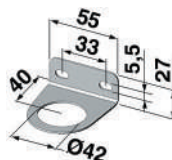

CODICE
C75.01.00018

KIT STAFFA A "T" SERIE 075 - 080



CODICE
C75.06.00011

KIT PER ASSEMBLAGGIO GRUPPI

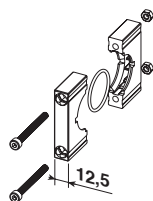

CODICE	PROD.
C75.05.00001	F+R+L
C75.06.00001	FR+L - F+L

PRESA D'ARIA

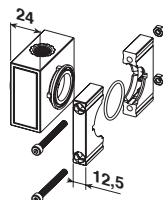

CODICE	CONNECTION	PROD.
Pres a d'aria intermedia		
C75.06.00002	1/4"	F+R+L - FR+L - F+L
Pres a d'aria ingresso		
C75.06.00004	1/4"- 1/2"	tutti
Pres a d'aria uscita		
C75.06.00005	1/4"- 1/2"	tutti

GRANO G1/8"



CODICE	PROD.
B38.00.00018	MR - MR P

TRATTAMENTO ARIA

VALVOLE

CILINDRI

RACCORDI

TRATTAMENTO ACQUA

LINEA 075 1/2 | ACCESSORI

PRESSOSTATO



CODICE	REF.
A50.06.00005	API-3-02-03-G

PRESA D'ARIA INTERMEDIA CON PRESSOSTATO LINEA 075



CODICE	REF.
C75.06.00008	PA 075 INTERMEDIA + API

PRESA D'ARIA TERMINALE CON PRESSOSTATO LINEA 075 - 1/2

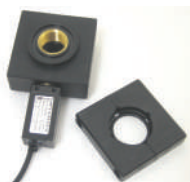

CODICE	REF.
C75.06.00009	PA INGRESSO 075 1/2 + API (INLET)
C75.06.00010	PA INGRESSO 075 1/2 + API (INLET)

SCARICO AUTOMATICO



CODICE	PROD.
C40.02.00130 SA	F - FR - MF
C42.02.00012 SAD	F - FR - MF

KIT MONTAGGIO SCARICO AUTOMATICO



CODICE	PROD.
C40.02.00131	SA - SAD

TRATTAMENTO ARIA

VALVOLE

CILINDRI

RACCORDI

TRATTAMENTO ACQUA

LINEA 075 1/2 | RICAMBI

GRUPPO MEMBRANA COMPLETO



CODICE	PROD.	VERSION
C75.01.00023	R - FR	RELIEVING

MOLLA REGOLAZIONE



CODICE	PROD.	SET REGULATION
A75.01.00030	R - FR	0÷4 Bar
A75.01.00031	R - FR	0÷8 Bar
A75.01.00032	R - FR	0÷12 Bar

TAZZA COMPLETA PER FILTRO



CODICE	PROD.	VERSION
C75.02.00022	F - FR - MF	PE SS

TAZZA CON SCARICO AUTOMATICO



CODICE	PROD.	VERSION
C75.02.00026	F - FR - MF	PE SA
C75.02.00103	F - FR - MF	PE SAD

TAZZA COMPLETA PER LUBRIFICATORE

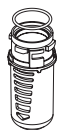

CODICE	PROD.	VERSION
C75.03.00022	IL	PE
C75.13.01000	VL	PE
C75.03.00075	IL	PE

GRUPPO FILTRAGGIO



CODICE	PROD.	VERSION
C75.02.00059	F	20 MICRON
C75.02.00064	FR	20 MICRON
C75.02.00063	F	5 MICRON
C75.02.00065	FR	5 MICRON
C75.02.00061	MF	0,01 MICRON
A75.02.00036	CF	CARBON

CUPOLA SPIA COMPLETA



CODICE	PROD.
C75.03.00018	L

TAPPO OLIO CON OR 2031



CODICE	PROD.
C75.03.00073	L

TRATTAMENTO ARIA

VALVOLE

CILINDRI

RACCORDI

TRATTAMENTO ACQUA

LINEA 080 3/4 | ACCESSORI

MANOMETRO

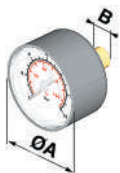

CODICE	Bar	Psi	A	B	CH.
A75.01.00010	0-12	0-175	50	G1/8"	14
A75.01.00011	0-6	0-85	50	G1/8"	14

MANOMETRO COMPATTO

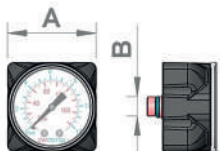

CODICE	Bar	Psi	A	B
A750100045	0-12	0-175	50	G1/8"

STAFFA FISSAGGIO A PARETE

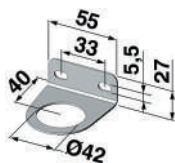

CODICE
C75.01.00018

KIT STAFFA A "T" SERIE 075 - 080



CODICE
C75.06.00011

KIT PER ASSEMBLAGGIO GRUPPI

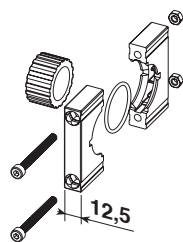

CODICE	PROD.
C80.05.00004	F+R+L
C80.06.00004	FR+L - F+L

KIT TERMINALE D'INGRESSO E D'USCITA

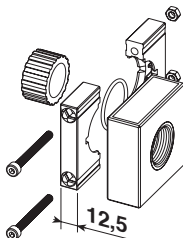

CODICE	CONNECTION	VERSION
C80.05.00002	3/4"	INPUT
C80.05.00003	3/4"	OUTPUT

GRANO G1/8"



CODICE	PROD.
B38.00.00018	MR - MR P

LINEA 080 3/4 | ACCESSORI

PRESA D'ARIA

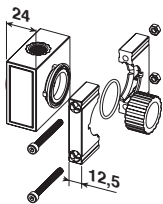

CODICE	CONNECTION	PROD.
C80.06.00005	1/4"	tutti / all

PRESSOSTATO



CODICE	REF.
A50.06.00005	AP1-3-02-03-G

SCARICO AUTOMATICO



CODICE	PROD.
C40.02.00130 SA	F - FR - MF
C42.02.00012 SAD	F - FR - MF

KIT MONTAGGIO SCARICO AUTOMATICO



CODICE	PROD.
C40.02.00131	SA - SAD

TRATTAMENTO ARIA

VALVOLE

CILINDRI

RACCORDI

TRATTAMENTO ACQUA

LINEA 080 3/4 | RICAMBI

GRUPPO MEMBRANA COMPLETO



CODICE	PRODOTTO	VERSIONE
C75.01.00023	R - FR	RELIEVING

MOLLA REGOLAZIONE



CODICE	PRODOTTO	SET REGULATION
A75.01.00030	R - FR	0÷4 Bar
A75.01.00031	R - FR	0÷8 Bar
A75.01.00032	R - FR	0÷12 Bar

TAZZA COMPLETA PER FILTRO



CODICE	PRODOTTO	VERSIONE
C75.02.00022	F - FR - MF	PE SS

TAZZA CON SCARICO AUTOMATICO



CODICE	PRODOTTO	VERSIONE
C75.02.00026	F - FR - MF	PE SA
C75.02.00103	F - FR - MF	PE SAD

TAZZA COMPLETA PER LUBRIFICATORE



CODICE	PRODOTTO	VERSIONE
C75.03.00022	IL	PE
C75.13.01000	VL	PE
C75.03.00075	IL	PE

GRUPPO FILTRAGGIO



CODICE	PRODOTTO	VERSIONE
C75.02.00059	F	20 MICRON
C75.02.00064	FR	20 MICRON
C75.02.00063	F	5 MICRON
C75.02.00065	FR	5 MICRON
C75.02.00061	MF	0,1 MICRON

CUPOLA SPIA COMPLETA



CODICE	PRODOTTO
C75.03.00018	L

TAPPO OLIO CON OR 2031



CODICE	PRODOTTO
C75.03.00073	L

LINEA 095 1" | ACCESSORI

MANOMETRO

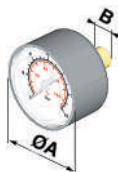

CODICE	Bar	Psi	A	B	CH.
A95.01.00026	0-12	0-175	63	G1/4"	14

KIT PER ASSEMBLAGGIO GRUPPI

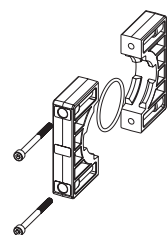

CODICE	PRODOTTO
C95.05.00001	F+R+L
C95.06.00001	FR+L - F+L

KIT DI STAFFAGGIO A PARETE

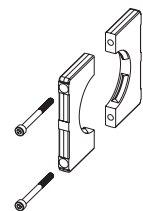

CODICE	PRODOTTO
C95.01.00015	R - F - L - FR

STAFFA FISSAGGIO A PARETE

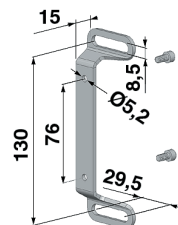

CODICE
C95.01.00018

SCARICO AUTOMATICO



CODICE	PRODOTTO
C40.02.00130 SA	F - FR
C42.02.00012 SAD	F - FR

KIT MONTAGGIO SCARICO AUTOMATICO



CODICE	PRODOTTO
C40.02.00131	SA - SAD

LINEA 095 1" | RICAMBI

TAZZA COMPLETA PER FILTRO



CODICE	PRODOTTO	VERSIONE
C95.02.00005	F - FR	PE SS

TAZZA CON SCARICO AUTOMATICO



CODICE	PRODOTTO	VERSIONE
C95.02.00006	F - FR	PE SA
C95.02.00019	F - FR	PE SAD

TAZZA COMPLETA PER LUBRIFICATORE

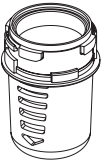

CODICE	PRODOTTO	VERSIONE
C95.03.00004	L	PE
C95.03.00007	IL	PE

ELEMENTO FILTRANTE

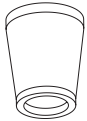

CODICE	PRODOTTO	VERSIONE
A95.02.00006	F - FR	20 MICRON
A95.02.00007	F - FR	5 MICRON

TRATTAMENTO ARIA

VALVOLE

CILINDRI

RACCORDI

TRATTAMENTO ACQUA

LINEA AP1 | PRESSOSTATO

TRATTAMENTO ARIA

VALVOLE

CILINDRI

RACCORDI

TRATTAMENTO ACQUA

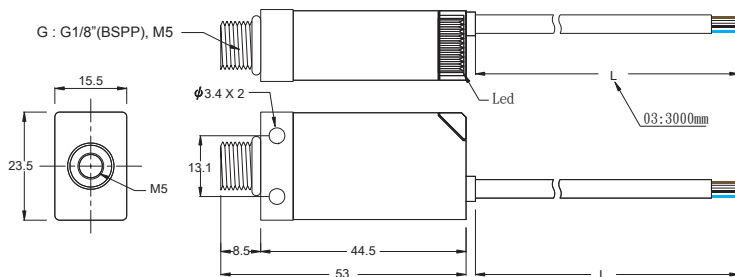

CARATTERISTICHE GENERALI

Il pressostato elettronico Aircomp AP1 è caratterizzato da grande versatilità d'impiego grazie alla possibilità di regolazione sia del punto di intervento che dell'isteresi.

* Di dimensioni particolarmente compatte si può montare su tutte le prese d'aria Aircomp.

* Viene proposto nella versione ad uscita digitale PNP con led di indicatore d'intervento.

* Campo di commutazione da 0 - 10 bar.

* Connessione pneumatica da 1/8" (con filetto interno M5).

DATI TECNICI

Fluido	aria, gas no corrosivi e non infiammabili
Campo di regolazione	0 - 10 bar
Pressione massima	15 bar
Tensione di alimentazione	12 - 24V DC +/- 10%
Tempo di risposta	5 ms o inferiore
Tipo di uscita	PNP 80 mA
Consumo corrente	21 mA max
Protezione IP	IP40
Temperatura ambiente	0 - 50 °C
Umidità ambiente	35 - 85% RH
Connessione	G 1/8" (M5 interno)
Lunghezza cavo	3 m
Peso	50 g
Led	rosso

GUIDA ALLE REFERENZE

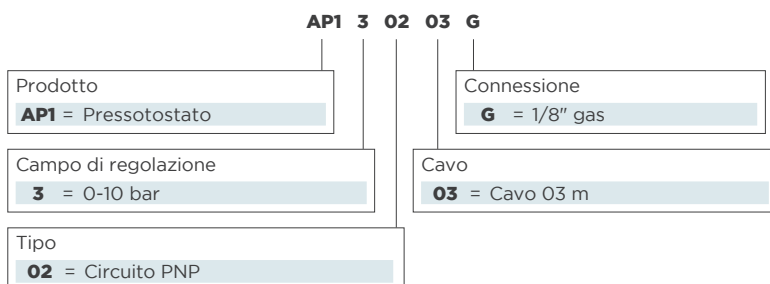

PRESSOSTATO



CODICE

A50.06.00005

REF.

AP1-3-02-03-G

ISTERESI REGOLABILE

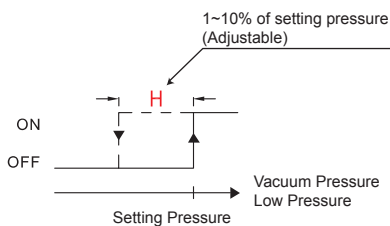

CIRCUITO PRESSOSTATO

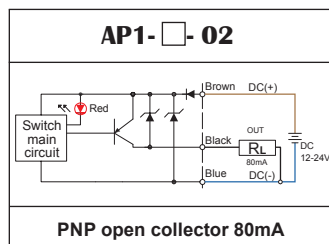

PRESA D'ARIA INTERMEDIA SLIM + PRESSOSTATO LINEA 042-1/4



CODICE	REF.
C42.05.00109	PA 042 1/8-1/4 (BATTERY) + AP1

PRESA D'ARIA TERMINALE CON PRESSOSTATO LINEA 042-1/4



CODICE	REF.
C42.05.00015	PA INGRESSO 042 + AP1 (INLET)
C42.05.00016	PA USCITA 042 + AP1 (OUTLET)

PRESA D'ARIA INTERMEDIA CON PRESSOSTATO LINEA 050 3/8-052 1/2



CODICE	REF.
C50.05.00006	PA 050 INTERMEDIA + AP1

PRESA D'ARIA TERMINALE CON PRESSOSTATO LINEA 050-3/8 - 052-1/2



CODICE	REF.
C50.05.00007	PA INGRESSO 050 3/8 + AP1 (INLET)
C50.05.00008	PA USCITA 050 3/8 + AP1 (OUTLET)

PRESA D'ARIA INTERMEDIA CON PRESSOSTATO LINEA 075-1/2



CODICE	REF.
C75.06.00008	PA 075 INTERMEDIA + AP1

PRESA D'ARIA TERMINALE CON PRESSOSTATO LINEA 075-1/2



CODICE	REF.
C75.06.00009	PA INGRESSO 075 1/2 + AP1 (INLET)
C75.06.00010	PA USCITA 075 1/2+ AP1 (OUTLET)

SA-SAD | SCARICO AUTOMATICO DELLA CONDENSA

TRATTAMENTO ARIA

VALVOLE

CILINDRI

RACCORDI

TRATTAMENTO ACQUA

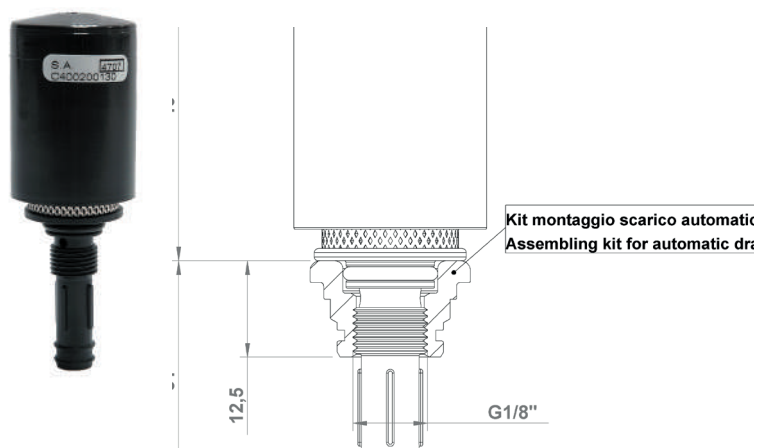

SA - SCARICO AUTOMATICO

Lo scarico automatico "SA" permette il drenaggio della condensa presente all'interno della tazza sia in presenza che assenza di pressione. Il funzionamento a galleggiante permette lo scarico della condensa accumulata nella tazza al raggiungimento del livello prestabilito. Lo scarico "SA" può essere montato su tutte le serie Aircomp (042, 050/052, 075, 080 e 095) per mezzo dell'apposito kit.

DATI TECNICI

Pressione minima d'intervento	1,5 bar
Pressione massima	10 bar

CODICI DI ORDINAZIONE

CODICE	REF.
C40.02.00130	scarico automatico "SA"
C40.02.00131	kit assemblaggio

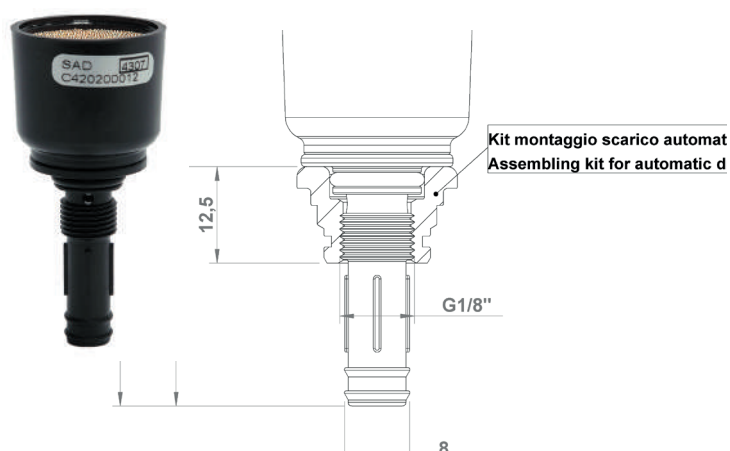

SAD - SCARICO AUTOMATICO DIFFERENZIALE

Lo scarico automatico "SAD" permette il drenaggio della condensa presente all'interno della tazza sia in presenza che in assenza di pressione.

Il funzionamento differenziale permette lo scarico della condensa solo se raggiunto il livello prestabilito.

Condizione necessaria per lo scarico della condensa è la presenza di un Δp minimo creato dal normale funzionamento del circuito (Δp minimo=0,2 bar).

DATI TECNICI

Pressione minima d'intervento	2 bar
Pressione massima	12 bar
Δp minimo	0,2 bar
Portata minima	30 lt/min

CODICI DI ORDINAZIONE

CODICE	REF.
C42.02.00012	scarico automatico differenziale "SAD"
C40.02.00131	kit assemblaggio