



nordair

RACCORDI STANDARD - ACCESSORI

STANDARD FITTINGS - ACCESSORIES
RACCORDS STANDARDS - ACCESSOIRES

RACCORDS STANDARDS - ACCESSOIRES
STANDARDVERSCHRAUBUNGEN



CARATTERISTICHE TECNICHE

CAMPI DI IMPIEGO: Circuiti pneumatici, oleodinamici e idraulici.

RACCORDI STANDARD: L - T - Y -CROCE - L PORTAGOMMA.

ACCESSORI: NIPPLO - RIDUZIONI - MANICOTTI - TAPPI - PORTAGOMMA - PASSAPARETE.

Pressione d'esercizio: La pressione nominale (BAR) dei raccordi è sempre superiore alla pressione di utilizzo del tubo. La pressione massima d'esercizio è determinata dalle caratteristiche del tubo impiegato.

Pressione massima consigliata 60 Bar.

Temperatura: La temperatura è determinata dalle caratteristiche del tubo impiegato.

Temperatura OR NBR 70: min.-20°C ; max. + 100°C

Temperatura OR VITON (FKM): min.-15°C ; max. +200°C

Materiali impiegati: Ottone UNI EN 12164 CW 614N. Ottone UNI EN 12165 CW 617N.

Trattamento superficiale: Nichelatura.

TECHNICAL FEATURES

FIELDS OF APPLICATION: Pneumatic, hydraulic and oil-hydraulic systems.

STANDARD FITTINGS: ELBOWS, TEES, Y, CROSS, HOSE CONNECTOR ELBOW.

ACCESSORIES: NIPPLES, REDUCERS, SLEEVES, PLUGS, HOSE CONNECTOR, BULKHEAD CONNECTOR

Working pressure: The pressure (BAR) of the fittings is always higher than the pressure used in the pipe. Pressure depend on the pipe's features used.

Max pressure suggested 60 Bar.

Temperature: The temperature depend on the pipe's features used.

Temperature O-Ring NBR 70 : min.-20° C ; max.+100°C

Temperature O-Ring VITON (FKM): min.-15°C ; max.+200°C

Materials used: Brass UNI EN 12164 CW 614N. Brass UNI EN 12165 CW 617N.

Surface treatment: Nickel-plating.

CARACTERISTICAS TECNICAS

CAMPOS DE EMPLEO: Circuitos neumáticos, oleodinámicos y hidráulicos.

RACORES ESTÁNDARES: CODO - TE - Y - CRUZ - CODO PORTATUBO.

ACCESORIOS: MACHÓN - REDUCCIONES - MANGUITOS - TAPÓN - ESPIGA - PASATABIQUES.

Presión: La presión nominal (BAR) de los racores es siempre mayor que la presión de trabajo en el tubo. La presión esta determinada por el tipo de tubo empleado, por lo tanto estos valores tienen que ser definidos por las características técnicas del tubo mismo.

Presión máxima aconsejada 60 Bar.

Temperatura: La temperatura esta determinada por el tipo de tubo empleado.

Temperatura O-Ring NBR: min.-20°C ; max. + 100°C

Temperatura O-Ring VITON (FKM): min.-15°C ; max. +200°C

Materiales empleados: Láton UNI EN 12164 CW 614N. Láton UNI EN 12165 CW 617N.

Tratamiento superficial: Niquelado.

RACCORDI STANDARD - ACCESSORI

STANDARD FITTINGS - ACCESSORIES
RACCORDS STANDARDS - ACCESSOIRES

RACCORDS STANDARDS - ACCESSOIRES
STANDARDVERSCHRAUBUNGEN

L M.M. COMPATTO
ELBOW M.M. COMPACT

CM

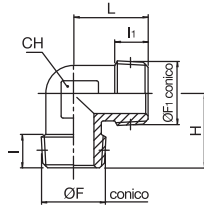

ARTICOLO	F	F1	I	I1	H	L	CH
CM1/8	1/8	1/8	8	8	17	17	10
CM1/4	1/4	1/4	11,5	11,5	22,5	22,5	12
CM3/8	3/8	3/8	12,5	12,5	25,5	25,5	15
CM1/2	1/2	1/2	14	14	30	30	19
CM3/4	3/4	3/4	17	17	34,5	34,5	22
CM1	1"	1"	18,5	18,5	40,5	40,5	28

L M.F. COMPATTO
ELBOW M.F. COMPACT

CHM

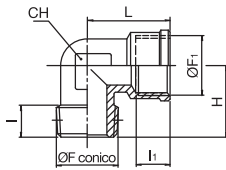

ARTICOLO	F	F1	I	I1	H	L	CH
CHM1/8	1/8	1/8	8	8	17	18,5	10
CHM1/4	1/4	1/4	11,5	11,5	22,5	22,5	12
CHM3/8	3/8	3/8	12,5	11,5	25,5	25,5	15
CHM1/2	1/2	1/2	14	14	30	30	19
CHM3/4	3/4	3/4	17	16,5	34,5	35,5	22
CHM1	1"	1"	19	18	40,5	40,5	28

L F.F. COMPATTO
ELBOW F.F. COMPACT

CH

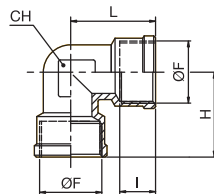

ARTICOLO	F	I	H	L	CH
CH1/8	1/8	8	18,5	18,5	10
CH1/4	1/4	11,5	22,5	22,5	12
CH3/8	3/8	11,5	25,5	25,5	15
CH1/2	1/2	14	30	30	19
CH3/4	3/4	16,5	35,5	35,5	22

T M.M.M. COMPATTO
TEE M.M.M. COMPACT

TM

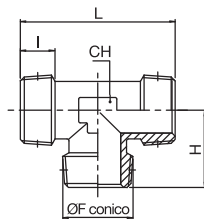

ARTICOLO	F	I	H	L	CH
TM1/8	1/8	8	17	34	10
TM1/4	1/4	11,5	22,5	45	12
TM3/8	3/8	12,5	25,5	51	15
TM1/2	1/2	14,5	30	60	19
TM3/4	3/4	17	34,5	69	22

T M.F.M. COMPATTO
TEE M.F.M. COMPACT

TCH

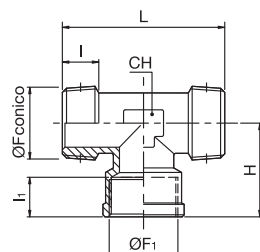

ARTICOLO	F	F1	I	I1	H	L	CH
TCH1/8	1/8	1/8	8	8	18,5	34	10
TCH1/4	1/4	1/4	11	11	22,5	45	12
TCH3/8	3/8	3/8	12,5	11,5	25,5	51	15
TCH1/2	1/2	1/2	14,5	14	30	60	19
TCH3/4	3/4	3/4	17	16,5	35,5	69	22

RACCORDI STANDARD - ACCESSORI

STANDARD FITTINGS - ACCESSORIES
RACCORDS STANDARDS - ACCESSOIRES

RACCORDS STANDARDS - ACCESSOIRES
STANDARDVERSCHRAUBUNGEN

T M.F.F. COMPATTO
TEE M.F.F. COMPACT



TLM

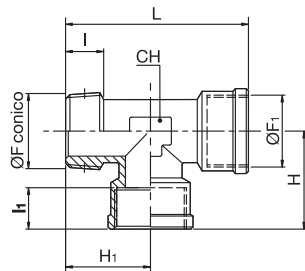

ARTICOLO	F	F1	I	I1	H	H1	L	CH
TLM1/8	1/8	1/8	8	8	18,5	17	35,5	10
TLM1/4	1/4	1/4	11,5	11	22,5	22,5	45	12
TLM3/8	3/8	3/8	12,5	11,5	25,5	25,5	51	15
TLM1/2	1/2	1/2	14,5	14	30	30	60	19
TLM3/4	3/4	3/4	17,5	16,5	35,5	34,5	70	22

T F.F.F. COMPATTO
TEE F.F.F. COMPACT



TH

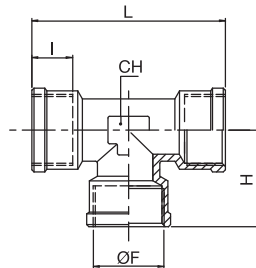

ARTICOLO	F	I	H	L	CH
TH1/8	1/8	8	18,5	37	10
TH1/4	1/4	11	22,5	45	12
TH3/8	3/8	11,5	25,5	51	15
TH1/2	1/2	14	30	60	19
TH3/4	3/4	16,5	35,5	71	22

T F.M.F. COMPATTO
TEE F.M.F. COMPACT



TCM

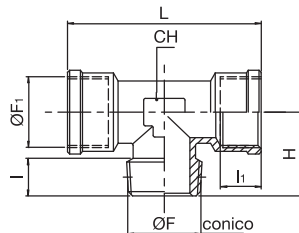

ARTICOLO	F	F1	I	I1	H	L	CH
TCM1/8	1/8	1/8	8	8	17	37	10
TCM1/4	1/4	1/4	11,5	11	22,5	45	12
TCM3/8	3/8	3/8	12,5	11,5	25,5	51	15
TCM1/2	1/2	1/2	14,5	14	30	60	19
TCM3/4	3/4	3/4	17	16,5	34,5	71	22

T M.M.F. COMPATTO
TEE M.M.F. COMPACT



TLH

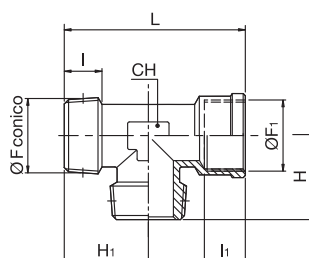

ARTICOLO	F	F1	I	I1	H	H1	L	CH
TLH1/8	1/8	1/8	8	8	17	17	35,5	10
TLH1/4	1/4	1/4	11,5	11	22,5	22,5	45	12
TLH3/8	3/8	3/8	12,5	11,5	25,5	25,5	51	15
TLH1/2	1/2	1/2	14,5	14	30	30	60	19
TLH3/4	3/4	3/4	17,5	16,5	34,5	34,5	70	22

RACCORDI STANDARD - ACCESSORI

STANDARD FITTINGS - ACCESSORIES
RACCORDS STANDARDS - ACCESSOIRES

RACCORDS STANDARDS - ACCESSOIRES
STANDARDVERSCHRAUBUNGEN

Y F.M.F.
Y F.F.F.



YCM

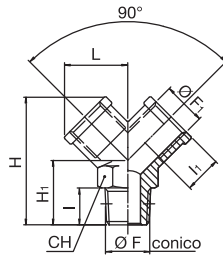

ARTICOLO	F	F1	I	I1	H	H1	L	CH
YCM1/8	1/8	1/8	8	8	32	16	14,5	13
YCM1/4	1/4	1/4	11	11	38	20	18	17
YCM3/8	3/8	3/8	11,5	11,5	42,5	22	20,5	20
YCM1/2	1/2	1/2	14	14	53	27	26,5	25

Y F.F.F.
Y F.F.F.



YCH

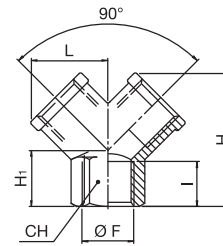

ARTICOLO	F	I	H	H1	L	CH
YCH1/8	1/8	8	26,5	12	14,5	13
YCH1/4	1/4	11	32	14	18	17
YCH3/8	3/8	11,5	37	16	20,5	20
YCH1/2	1/2	14	45	19	26,5	25

CROCE M.F.F.F.
CROSS M.F.F.F.



XCM

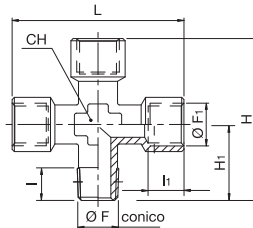

ARTICOLO	F	F1	I	I1	H	H1	L	CH
XCM1/8	1/8	1/8	8	8	39	18,5	42	10
XCM1/4	1/4	1/4	11	11			51	13
XCM3/8	3/8	3/8	11,5			26	56	17
XCM1/2	1/2	1/2	14	14		31	67	21

CROCE F.F.F.F.
CROSS F.F.F.F.



XH

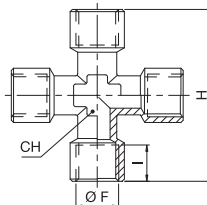

ARTICOLO	F	I	H	CH
XH1/8	1/8	8	42	10
XH1/4	1/4	11	51	13
XH3/8	3/8	11,5	56	17
XH1/2	1/2	14	67	21

GHIERA FOLLE
RING NUT



TU

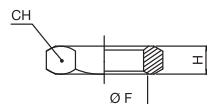



ARTICOLO	F	H	CH
TU1/8	1/8	4,5	14
TU1/4	1/4	5	17
TU3/8	3/8	5,5	19
TU1/2	1/2	6	24

RACCORDI STANDARD - ACCESSORI

STANDARD FITTINGS - ACCESSORIES
RACCORDS STANDARDS - ACCESSOIRES

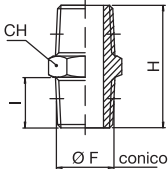
RACCORDS STANDARDS - ACCESSOIRES
STANDARDVERSCHRAUBUNGEN

NIPPO CONICO NIPPLE CONICAL		N	ARTICOLO	F	I	H	CH
			N1/8	1/8	8	20,5	12
			N1/4	1/4	11	27	14
			N3/8	3/8	11,5	28	17
			N1/2	1/2	14	33,5	22
			N3/4	3/4	16,5	39,5	27
			N1	1"	19	45,5	34

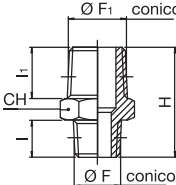
NIPPO RIDUZIONE CONICO REDUCING NIPPLE CONICAL		N	ARTICOLO	F	F1	I	I1	H	CH
			N1/8-1/4	1/8	1/4	8	11	24	14
			N1/8-3/8	1/8	3/8	8	11,5	24,5	17
			N1/4-3/8	1/4	3/8	11	11,5	27,5	17
			N1/4-1/2	1/4	1/2	11	14	30,5	22
			N3/8-1/2	3/8	1/2	11,5	14	31	22
			N1/2-3/4	1/2	3/4	14	16,5	37	27
			N3/4-1	3/4	1"	16,5	19	42,5	34

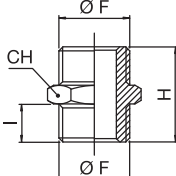
NIPPO CILINDRICO NIPPLE CYLINDRICAL		N-C	ARTICOLO	F	I	H	CH
			N-M5	M5	4	11,5	8
			N1/8C	1/8	6	16,5	14
			N1/4C	1/4	8	21	17
			N3/8C	3/8	9	23	19
			N1/2C	1/2	10	25,5	24
			N3/4C	3/4	11	28,5	30
			N1C	1"	14	35	36

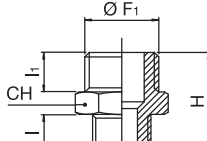
NIPPO RIDUZIONE CILINDRICO REDUCING NIPPLE CYLINDRICAL		N-C	ARTICOLO	F	F1	I	I1	H	CH
			N-M5-1/8	M5	1/8	4	6	14,5	14
			N1/8-1/4C	1/8	1/4	6	8	19	17
			N1/8-3/8C	1/8	3/8	6	9	20	19
			N1/4-3/8C	1/4	3/8	8	9	22	19
			N1/4-1/2C	1/4	1/2	8	10	23,5	24
			N3/8-1/2C	3/8	1/2	9	10	24,5	24
			N1/2-3/4C	1/2	3/4	10	11	27,5	30
			N3/4-1C	3/4	1"	12	11	30	36

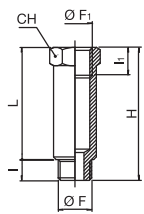
RIDUZIONE PROLUNGA M.F. EXSTENSION CYLINDRICAL M.F.		P	ARTICOLO	F	F1	I	I1	L	H	CH
			P1/8-16	1/8	1/8	6	8	16	22	14
			P1/8-36	1/8	1/8	6	8	36	42	14
			P1/4-27	1/4	1/4	8	11	27	35	17
			P1/4-43	1/4	1/4	8	11	43	51	17

RACCORDI STANDARD - ACCESSORI

STANDARD FITTINGS - ACCESSORIES
RACCORDS STANDARDS - ACCESSOIRES

RACCORDS STANDARDS - ACCESSOIRES
STANDARDVERSCHRAUBUNGEN

MAGGIORAZIONE MASCHIO CONICA-FEMMINA

EXSTENSION MALE CONICAL-FEMALE

RL

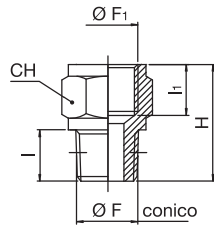

ARTICOLO	F	F1	I	I1	H	CH
RL1/8-1/4	1/8	1/8	8	8	18	14
RL1/4-1/8	1/8	1/4	8	11	21,5	17
RL3/8-1/8	1/8	3/8	8	11,5	22,5	22
RL1/4-1/4	1/4	1/4	11	11	24,5	17
RL3/8-1/4	1/4	3/8	11	11,5	25,5	22
RL1/2-1/4	1/4	1/2	11	14	29	24
RL3/8-3/8	3/8	3/8	11,5	11,5	26	22
RL1/2-3/8	3/8	1/2	11,5	14	29,5	24
RL1/2-1/2	1/2	1/2	14	14	32	26
RL3/4-1/2	1/2	3/4	14	16,5	35	32

MAGGIORAZIONE MASCHIO CILINDRICA-FEMMINA

EXSTENSION MALE CYLINDRICAL-FEMALE

RL-C

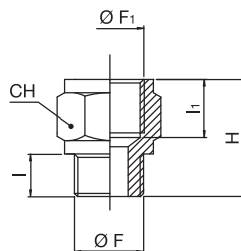

ARTICOLO	F	F1	I	I1	H	CH
RL1/8-M5	M5	1/8	4	8	14,5	14
RL1/8-1/8C	1/8	1/8	6	8	16,5	14
RL1/4-1/8C	1/8	1/4	6	11	19,5	17
RL1/4-1/4C	1/4	1/4	8	11	21,5	17
RL3/8-1/4C	1/4	3/8	8	11,5	22,5	22
RL3/8-3/8C	3/8	3/8	9	11,5	23,5	22
RL1/2-3/8C	3/8	1/2	9	14	27	24
RL1/2-1/2C	1/2	1/2	10	14	28	26

PASSAPARETE F.F.

BULKHEAD F.F.

PT

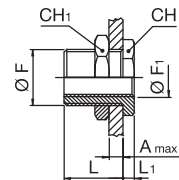

ARTICOLO	F	F1	A _{MAX}	L	L1	CH	CH1
PT-M5	M10X1	M5	7	10,5	3,5	14	14
PT1/8	M16X1,5	1/8	10	14	4	19	22
PT1/4	M20X1,5	1/4	16	21	4	24	27
PT3/8	M26X1,5	3/8	15	21	5	30	32
PT1/2	M28X1,5	1/2	21	27	6	32	36

RIDUZIONE CONICA M.F.

REDUCER ADAPTOR CONICAL M.F.

RC

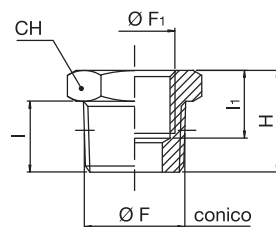

ARTICOLO	F	F1	I	I1	H	CH
RC1/8-1/4	1/4	1/8	11	8	16	14
RC1/8-3/8	3/8	1/8	11,5	8	16,5	17
RC1/4-3/8	3/8	1/4	11,5	11	16,5	17
RC1/8-1/2	1/2	1/8	14	8	19,5	22
RC1/4-1/2	1/2	1/4	14	11	19,5	22
RC3/8-1/2	1/2	3/8	14	11,5	19,5	22
RC3/8-3/4	3/4	3/8	16,5	11,5	23	27
RC1/2-3/4	3/4	1/2	16,5	14	23	27
RC1/2-1	1"	1/2	19	14	27	34
RC3/4-1	1"	3/4	19	16,5	27	34

RIDUZIONE CILINDRICA M.F.

REDUCER ADAPTOR CYLINDRICAL M.F.

RC-C

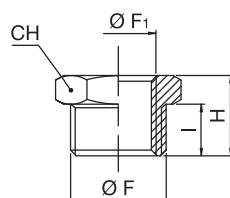

ARTICOLO	F	F1	I	H	CH
RC-M5-1/8	1/8	M5	6	10,5	14
RC1/8-1/4C	1/4	1/8	8	13	17
RC1/8-3/8C	3/8	1/8	9	14	19
RC1/4-3/8C	3/8	1/4	9	14	19
RC1/4-1/2C	1/2	1/4	10	15,5	24
RC3/8-1/2C	1/2	3/8	10	15,5	24
RC1/2-3/4C	3/4	1/2	11	17,5	30
RC3/4-1C	1"	3/4	11,5	18,5	36

RACCORDI STANDARD - ACCESSORI

STANDARD FITTINGS - ACCESSORIES
RACCORDS STANDARDS - ACCESSOIRES

RACCORDS STANDARDS - ACCESSOIRES
STANDARDVERSCHRAUBUNGEN

MANICOTTO
SLEEVE



M

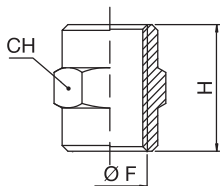

ARTICOLO	F	H	CH
M1/8	1/8	15	14
M1/4	1/4	22	17
M3/8	3/8	23	22
M1/2	1/2	28	26
M3/4	3/4	32	32

MANICOTTO RIDUZIONE
REDUCING SLEEVE



M

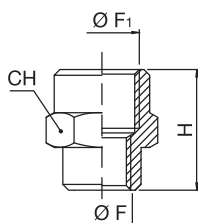

ARTICOLO	F	F1	H	CH
M1/8-1/4	1/8	1/4	19	17
M1/8-3/8	1/8	3/8	20	22
M1/4-3/8	1/4	3/8	22,5	22
M1/4-1/2	1/4	1/2	26	24
M3/8-1/2	3/8	1/2	26	24
M1/2-3/4	1/2	3/4	30	32

TAPPO MASCHIO CILINDRICO
PLUG MALE CYLINDRICAL



T

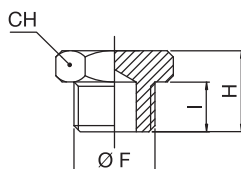

ARTICOLO	F	I	H	CH
T1/8	1/8	6	10	14
T1/4	1/4	8	12,5	17
T3/8	3/8	9	13,5	19
T1/2	1/2	10	15,5	24
T3/4	3/4	11	16,5	30

**TAPPO MASCHIO CILINDRICO
CON BRUGOLA CON OR**
ALLEN KEY PLUG WITH O-RING



TAO

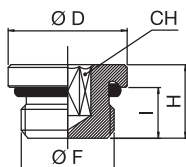

ARTICOLO	F	I	H	D	CH
TAO1/8	1/8	6,5	9,5	14	5
TAO1/4	1/4	8	11,5	17	6
TAO3/8	3/8	9	12,5	20	8
TAO1/2	1/2	10	14	26	10

**TAPPO MASCHIO CONICO
(A SCOMPARSA)**
SOCKET HEAD PLUG CONICAL



TA

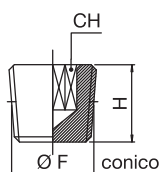

ARTICOLO	F	H	CH
TA1/8	1/8	7,5	5
TA1/4	1/4	10	6
TA3/8	3/8	11	8
TA1/2	1/2	13	10

RACCORDI STANDARD - ACCESSORI

STANDARD FITTINGS - ACCESSORIES
RACCORDS STANDARDS - ACCESSOIRES

RACCORDS STANDARDS - ACCESSOIRES
STANDARDVERSCHRAUBUNGEN

TAPPO FEMMINA
PLUG FEMALE



THE

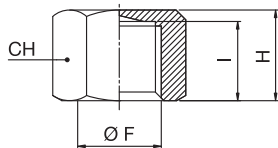

ARTICOLO	F	I	H	CH
THE1/8	1/8	8	10	14
THE1/4	1/4	11	13,5	17
THE3/8	3/8	11,5	14	20
THE1/2	1/2	14	16,5	24
THE3/4	3/4	16	18,5	30

PORTAGOMMA FEMMINA
HOSE CONNECTOR FEMALE



AGH

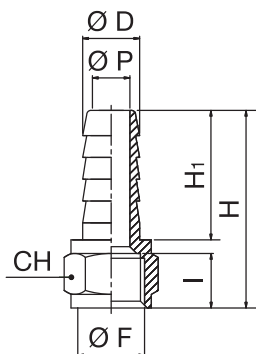

ARTICOLO	D	F	P	I	H	H1	CH
AGH6-1/8	6	1/8	3,5	8	28,5	19	12
AGH7-1/8	7	1/8	4,5	8	28,5	19	12
AGH7-1/4	7	1/4	4,5	11	31,5	19	15
AGH9-1/4	9	1/4	6,5	11	31,5	19	15
AGH10-3/8	10	3/8	7,5	11,5	33	20	19
AGH12-3/8	12	3/8	9,5	11,5	33	20	19
AGH12-1/2	12	1/2	9,5	14	36	20	24

PORTAGOMMA MASCHIO CILINDRICO
HOSE CONNECTOR MALE CYLINDRICAL



AG

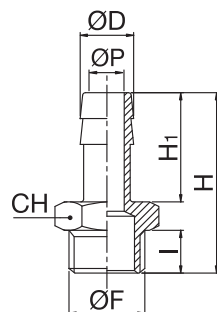

ARTICOLO	D	F	P	I	H	H1	CH
AG6-1/8	6	1/8	3	6	29,5	19	12
AG7-1/8	7	1/8	4	6	29,5	19	12
AG7-1/4	7	1/4	4	8	32	19	14
AG8-1/8	8	1/8	5	6	29,5	19	12
AG9-1/8	9	1/8	6	6	29,5	19	12
AG9-1/4	9	1/4	6	8	32	19	14
AG9-3/8	9	3/8	6	9	33	19	19
AG10-1/4	10	1/4	7	8	33	20	14
AG10-3/8	10	3/8	7	9	34	20	19
AG12-1/4	12	1/4	9	8	33	20	14
AG12-3/8	12	3/8	9	9	34	20	19
AG12-1/2	12	1/2	9	10	35,5	20	22
AG14-3/8	14	3/8	10,5	9	36	22	19
AG14-1/2	14	1/2	10,5	10	37,5	22	22
AG17-3/8	17	3/8	13	9	38	24	19
AG17-1/2	17	1/2	13	10	39,5	24	22
AG20-1/2	20	1/2	14	10	39,5	24	22
AG20-3/4	20	3/4	16	11	41,5	24	30