

## CILINDROS NEUMATICOS

## SENSORES MAGNÉTICOS

---

FIJ. SENSOR CIL. ISO6432 Ø10

Referencia: **SF10**



ISO 6431

SF (ISO 6432)

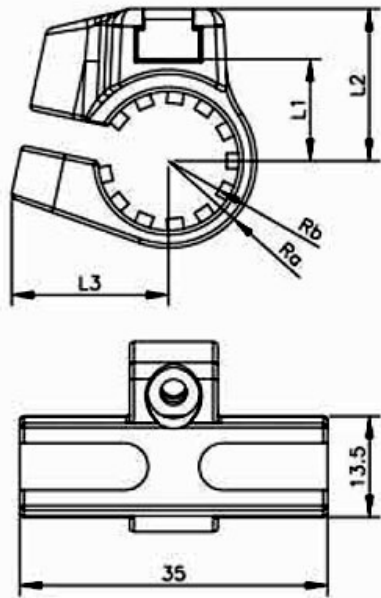

SCM32 (ø32-63)

SCM80 (ø80-100)

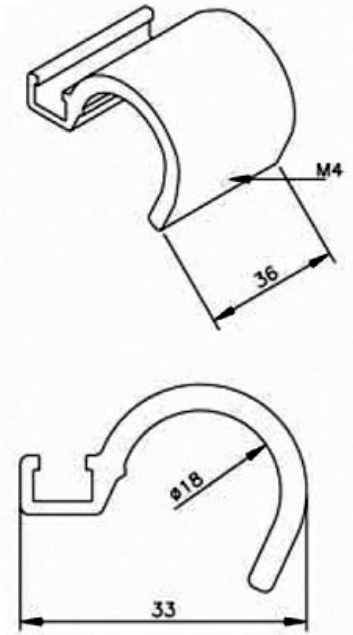
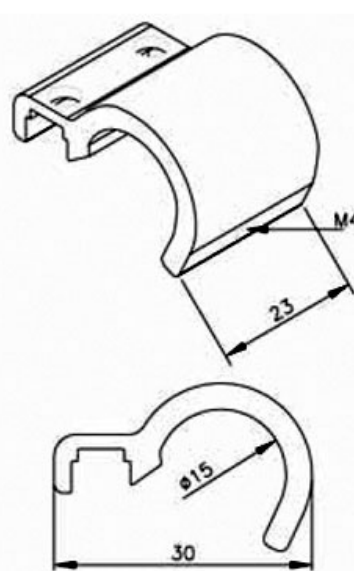

ISO 6431 (CON TIRANTES)

SCT32 (ø32-63)

SCT(ø80-100)

