

CILINDROS NEUMATICOS

SENSORES MAGNÉTICOS

FIJ. SENSOR CIL. ISO6432 Ø12

Referencia: **SF12**



ISO 6431

SF (ISO 6432)

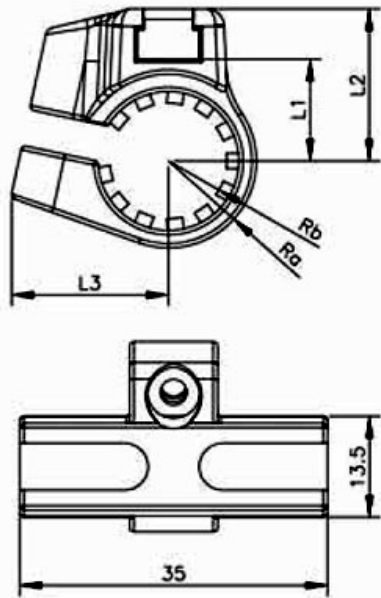

SCM32 (ø32-63)

SCM80 (ø80-100)

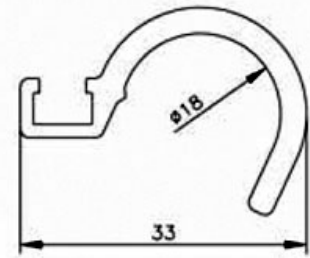
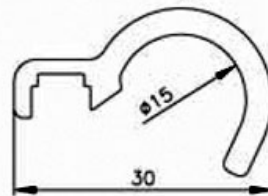
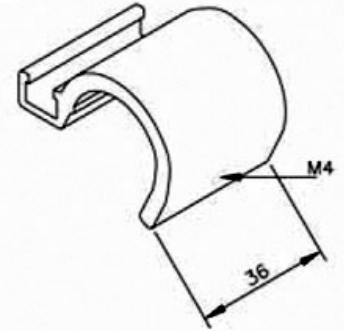
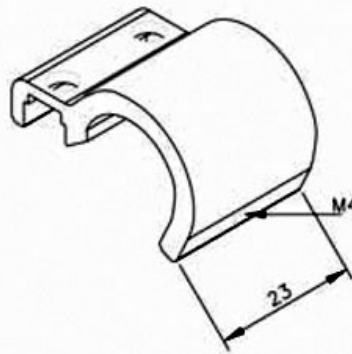

ISO 6431 (CON TIRANTES)

SCT32 (ø32-63)

SCT(ø80-100)

