

ACCESORIOS ROSCADOS INOX

Raccordi Standard in Acciaio Inox 316L
316L Stainless Steel Standard Fittings
Raccords Standard en Acier Inox 316L
Standardverschraubungen aus Edelstahl 1.4404



La serie è costituita da raccordi standard in acciaio inox AISI 316L ed è il complemento delle serie di raccordi ad innesto rapido, a calzamento e dei raccordi a funzione in acciaio inossidabile.



Are our standard fittings in stainless steel AISI 316L; the right complement to our AISI 316L Fittings programm.



Sont nos raccords standards en acier AISI 316L; le juste complément à notre gamme de raccords complètement en INOX 316L.



Kennzeichnet unsere Zubehöreserie aus Edelstahl AISI 316L; die Ergänzung zu unserem AISI 316L Verschraubungsprogramm.

ACCESORIOS INOX

1	2
Corpo Body Corps Körper	Guarnizioni Seals Joint d'étanchéité Dichtung
Acciaio Inox AISI 316L (1.4404) Stainless Steel AISI 316L (1.4404) Acier Inox AISI 316L (1.4404) Edelstahl AISI 316L (1.4404)	FPM FPM FPM FPM

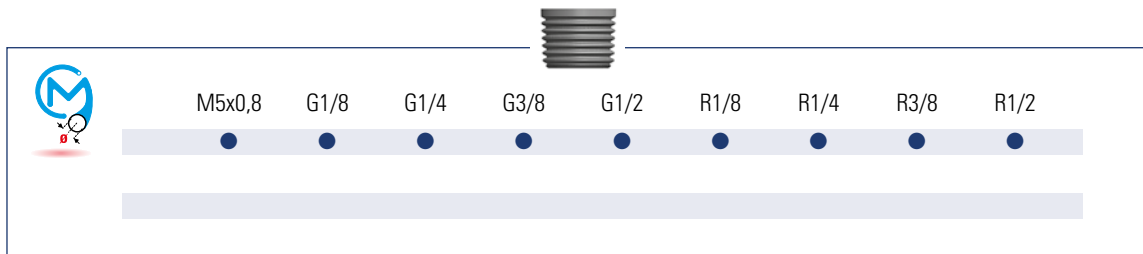
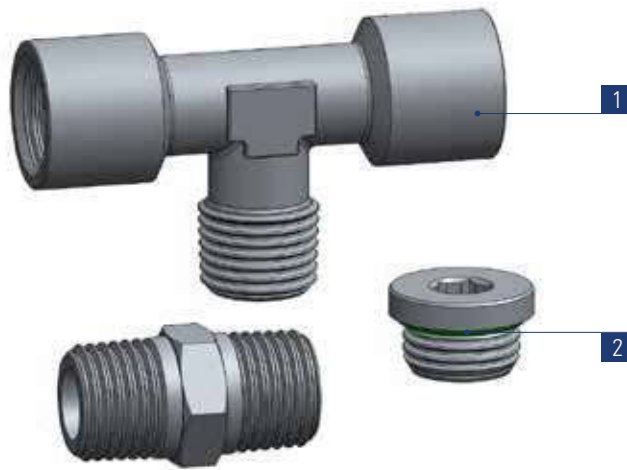

Campi di applicazione:
Pneumatica, Industria Alimentare, Chimica e
Medicale-Farmaceutica.

Application fields:
Pneumatics, Food Industry, Chemical,
Medical and Pharmaceutical Industry.

Domaines d'application:
Pneumatique, Industrie alimentaire,
Chimique, Médicale et Pharmaceutique.

Anwendungsbereiche:
Pneumatik, Nahrungswirtschaft, chemische,
medizinische und pharmazeutische Industrie.

NX

Nipplo Conico

Nipple, taper

Mamelon conique

Doppelnippel, kegelig

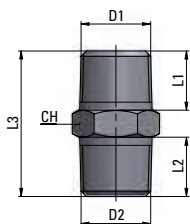

Tipo	D1	D2	L1	L2	L3	CH	g Δ
NX1/8	R1/8	R1/8	7,5	7,5	20	12	8,1
NX1/8-1/4	R1/8	R1/4	7,5	11	23,5	14	12,5
NX1/4	R1/4	R1/4	11	11	27	14	14,8
NX1/4-3/8	R1/4	R3/8	11	11,5	27,5	17	20,9
NX3/8	R3/8	R3/8	11,5	11,5	28	17	24,3
NX3/8-1/2	R3/8	R1/2	11,5	14	31,5	22	38,5
NX1/2	R1/2	R1/2	14	14	34	22	38,9

MX

Manicotto

Joint Piece

Manchon

Muffe

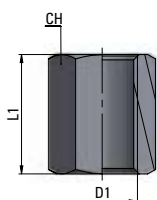

Tipo	D1	L1	CH	g Δ
MX1/8	G1/8	15	14	11,8
MX1/4	G1/4	22	17	21,6
MX3/8	G3/8	24	22	40,5
MX1/2	G1/2	30	27	73,5

RCX

Riduzione F-M Conica

Taper Female-Male reducing connector

Réduction Femelle-Mâle, conique

Reduzierstück, Auf-Einschraub, kegelig

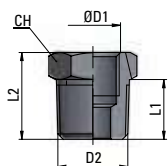

Tipo	D1	D2	L1	L2	CH	g Δ
RCX1/8-1/4	G1/8	R1/4	11	16	14	8,8
RCX1/8-3/8	G1/8	R3/8	11,5	16,5	17	18,6
RCX1/8-1/2	G1/8	R1/2	14	19,5	22	32
RCX1/4-3/8	G1/4	R3/8	11,5	16,5	17	11,9
RCX1/4-1/2	G1/4	R1/2	14	19,5	22	34,6
RCX3/8-1/2	G3/8	R1/2	14	19,5	22	22,7

RCX-C

Riduzione F-M Cilindrica

Parallel Female-Male reducing connector

Réduction Femelle-Mâle, cylindrique

Reduzierstück, Auf-Einschraub, zylindrisch

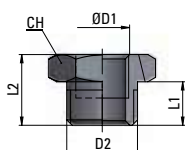

Tipo	D1	D2	L1	L2	CH	g Δ
RCX-M5-1/8	M5x0,8	G1/8	6	10,5	14	7,8
RCX1/8-1/4C	G1/8	G1/4	8	13	17	10,5
RCX1/4-3/8C	G1/4	G3/8	9	14	19	12,7

CHX

Gomito F-F

Female Elbow

Equerre Femelle

Aufschaub-Winkel

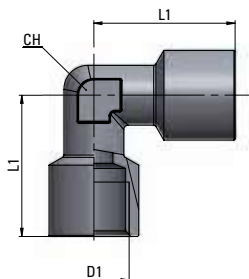

Tipo	D1	L1	CH	g $\Delta\Delta$
CHX1/8	G1/8	22	10	19
CHX1/4	G1/4	26	12	37,4
CHX3/8	G3/8	28	17	44
CHX1/2	G1/2	34	19	75,6

CHMX

Gomito M-F

Male-Female Elbow

Equerre Mâle-Femelle

Auf-Einschraub-Winkel

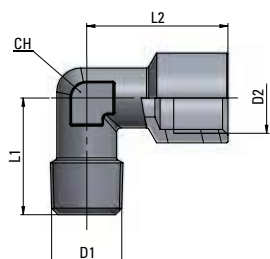

Tipo	D1	D2	L1	L2	CH	g $\Delta\Delta$
CHMX1/8	R1/8	G1/8	17	22	10	16,3
CHMX1/4	R1/4	G1/4	21,5	26	12	37,5
CHMX3/8	R3/8	G3/8	24,5	28	17	40,9
CHMX1/2	R1/2	G1/2	30,5	34	19	71,8

THX

T F-F-F

Female T

Té Femelle

T-Aufschraub

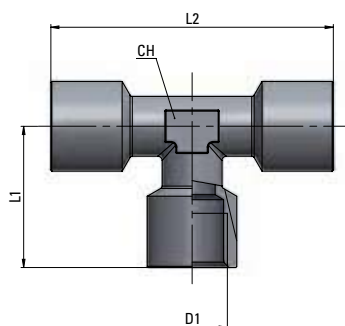

Tipo	D1	L1	L2	CH	g $\Delta\Delta$
THX1/8	G1/8	22	44	10	26,6
THX1/4	G1/4	26	52	12	48,8
THX3/8	G3/8	28	56	17	60
THX1/2	G1/2	34	68	19	108,5

TCMX

T F-M-F

Male-Female Stud Tee

Té Femelle-Mâle-Femelle

T Auf-Einschraub

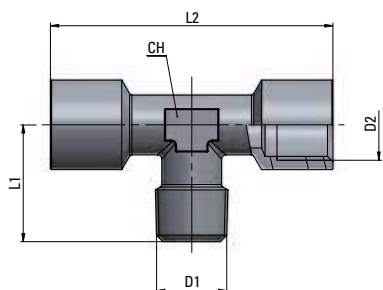

Tipo	D1	D2	L1	L2	CH	g $\Delta\Delta$
TCMX1/8	R1/8	G1/8	17	44	10	24,7
TCMX1/4	R1/4	G1/4	21,5	52	12	51,4
TCMX3/8	R3/8	G3/8	24,5	56	17	57,5
TCMX1/2	R1/2	G1/2	30,5	68	19	101,4

CMX

Gomito M-M

Male-Male Elbow

Equerre Mâle

Einschraub-Winkelstück

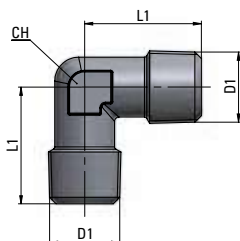

Tipo	D1	D2	L1	CH	g Δ
CMX1/8	R1/8	R1/8	17	10	10,1
CMX1/4	R1/4	R1/4	21,5	12	20,3
CMX3/8	R3/8	R3/8	24,5	17	37,9
CMX1/2	R1/2	R1/2	30,5	19	62

XCOH

Anello filettato

Single Banjo Ring

Bague orientable simple

Einfaches Schwenkringstück

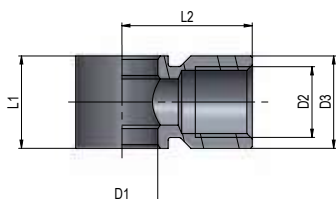

Tipo	D1	D2	D3	L1	L2	g Δ
XCOH1/8	10	G1/8	14	15	18,5	15,8
XCOH1/4	13,2	G1/4	17	17	24	24,3
XCOH3/8	17	G3/8	20	20	29	40
XCOH1/2	21	G1/2	26	24	34,5	63,8

TAX

Tappo Conico

Taper Plug

Bouchon cône

Verschlussstopfen, kegelig

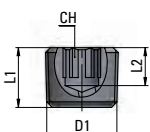

Tipo	D1	L1	L2	CH	g Δ
TAX1/8	R1/8	7,5	6	5	2,6
TAX1/4	R1/4	11	8	6	8,4
TAX3/8	R3/8	11,5	8	10	13,3
TAX1/2	R1/2	14	9,5	10	25,7

TAOX

Tappo Maschio con Oring

Male Plug with Oring

Bouchon Mâle avec Oring

Einschraubstopfen mit Oring

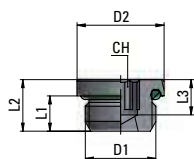

Tipo	D1	D2	L1	L2	L3	CH	g Δ
TAOX1/8	G1/8	13	5	7,5	4,5	5	4,1
TAOX1/4	G1/4	16	6,5	9,5	5,5	6	8,3
TAOX3/8	G3/8	20	7	10	6	8	14,2
TAOX1/2	G1/2	25	8,5	12	7	10	28,8